



# Configuration Guide

## Wireless Controller

AC50/AC500

1910012437 REV1.0.2

June 2018

# Content

<b>About This Guide .....</b>	<b>1</b>
<b>1 Quick Start.....</b>	<b>2</b>
1.1 Determine the Network Topology .....	2
1.1.1 Manage CAPs in the LAN.....	2
1.1.2 Manage CAPs in Different Network Segment.....	3
1.2 Log In to the AC .....	3
1.2.1 Preparations.....	3
1.2.2 Log In.....	4
<b>2 Status .....</b>	<b>7</b>
2.1 System Status .....	7
2.2 Client Status.....	8
2.3 AP Status.....	9
2.4 Authentication Status.....	10
2.4.1 Authentication Status .....	10
2.4.2 Non-sense Authenticated User .....	11
<b>3 Network .....</b>	<b>12</b>
3.1 Interface.....	12
3.2 DHCP Server .....	13
3.2.1 DHCP Server .....	13
3.2.2 DHCP Client List.....	15
3.2.3 Address Reservation.....	15
3.3 VLAN .....	16
3.3.1 VLAN.....	16
3.3.2 Ports.....	18
3.3.3 Relations.....	19
3.4 Switch.....	20
3.4.1 Statistics.....	20
3.4.2 Mirror .....	21
3.4.3 Rate Control.....	21

3.4.4	Port Config.....	22
3.4.5	Port Status.....	23
<b>4</b>	<b>AP Control.....</b>	<b>24</b>
4.1	AP Settings.....	24
4.2	AP Firmware Upgrade.....	27
4.3	AP Database.....	28
4.4	Load Balancing.....	29
<b>5</b>	<b>Radio.....</b>	<b>31</b>
5.1	Radio Settings.....	31
5.2	Rate Settings.....	34
5.3	Band Steering.....	36
5.4	Wi-Fi Roaming.....	37
<b>6</b>	<b>Wireless.....</b>	<b>39</b>
6.1	Wireless Service.....	39
<b>7</b>	<b>Authentication.....</b>	<b>43</b>
7.1	MAC Authentication.....	43
7.1.1	MAC Address.....	44
7.1.2	MAC Authentication.....	45
7.2	Portal Authentication.....	46
7.2.1	Splash Page.....	47
7.2.2	Web Authentication.....	49
7.2.3	Onekey Online.....	53
7.2.4	Voucher.....	54
7.2.5	SMS.....	56
7.2.6	Facebook.....	58
7.2.7	Remote Portal.....	60
7.3	Local User Management.....	64
7.4	Voucher Management.....	68
7.4.1	Create Voucher.....	68
7.4.2	Manage Voucher.....	69
7.5	Authentication Server.....	69

7.5.1	Radius Server.....	70
7.5.2	Authentication Server Group.....	71
<b>7.6</b>	<b>Authentication Config .....</b>	<b>72</b>
7.6.1	Free Authentication Policy.....	72
7.6.2	Authentication Parameters.....	75
<b>7.7</b>	<b>Applications .....</b>	<b>75</b>
7.7.1	Application for Web Authentication.....	75
7.7.2	Application for Onekey Online .....	80
7.7.3	Application for Voucher.....	81
7.7.4	Application for SMS.....	85
7.7.5	Application for Facebook.....	88
7.7.6	Application for Remote Portal.....	91
<b>8</b>	<b>Link Backup.....</b>	<b>94</b>
8.1	Dual-link Backup.....	94
8.2	Application.....	95
<b>9</b>	<b>System Tools.....</b>	<b>98</b>
9.1	Account.....	98
9.1.1	Administrator Account.....	98
9.1.2	Operator Account.....	99
9.1.3	System Settings.....	99
9.2	Administration.....	100
9.2.1	Factory Default Restore.....	100
9.2.2	Backup & Restore.....	100
9.2.3	Reboot.....	101
9.2.4	Firmware Upgrade.....	102
9.3	Traffic Statistics.....	102
9.4	Diagnostics.....	103
9.5	Time Settings.....	104
9.6	System Log.....	107

# About This Guide

This Configuration Guide provides information for managing AC500/AC50 Series Wireless Controller. Please read this guide carefully before operation.

## Intended Readers

This Guide is intended for network managers familiar with IT concepts and network terminologies.

## Conventions

When using this guide, please notice that features of the device may vary slightly depending on the model and software version you have. All screenshots, images, parameters and descriptions documented in this guide are used for demonstration only.

The information in this document is subject to change without notice. Every effort has been made in the preparation of this document to ensure accuracy of the contents, but all statements, information, and recommendations in this document do not constitute the warranty of any kind, express or implied. Users must take full responsibility for their application of any products.

In this Guide, the following conventions are used:

Notes contains suggestions or references that helps you make better use of your device.

For GUI, Menu Name > Submenu Name > Tab page indicates the menu structure. Network > DHCP Server > DHCP Client List means the DHCP Client List page under the DHCP Server menu option that is located under the Network menu.

Bold font indicates a button, a toolbar icon, menu or menu item.

## More Information

- The latest software and documentations can be found at Download Center at <https://www.tp-link.com/support>.
- The Installation Guide (IG) can be found where you find this guide or inside the package of the wireless controller.
- Specifications can be found on the product page at <https://www.tp-link.com>.
- A Technical Support Forum is provided for you to discuss our products at <https://forum.tp-link.com>.
- Our Technical Support contact information can be found at the Contact Technical Support page at <https://www.tp-link.com/support>.

# 1 Quick Start

The wireless controller (AC) is a device used for centralized management of access points (APs). At present, the supported APs are TP-Link's CAPs. The AC can configure CAPs in batches using a web browser and conduct a real-time monitoring of each CAP in the network. This AC supports AP automatic discovery, AP status monitoring, AP centralized control, MAC filtering, radio management, load balance, dual-link backup and various authentication types.

This wireless controller makes it easier to configure and manage dozens or hundreds of CAPs in a large public environment, such as markets, hotels, companies and campuses, etc. AC500 wireless controller supports to manage 500 CAPs at the same time and AC50 wireless controller supports 50 CAPs.

## 1.1 Determine the Network Topology

You can use the AC to centrally manage the CAPs in the same or different network segment.

### 1.1.1 Manage CAPs in the LAN

If you want to manage the CAPs in the LAN, refer to the following network topology.

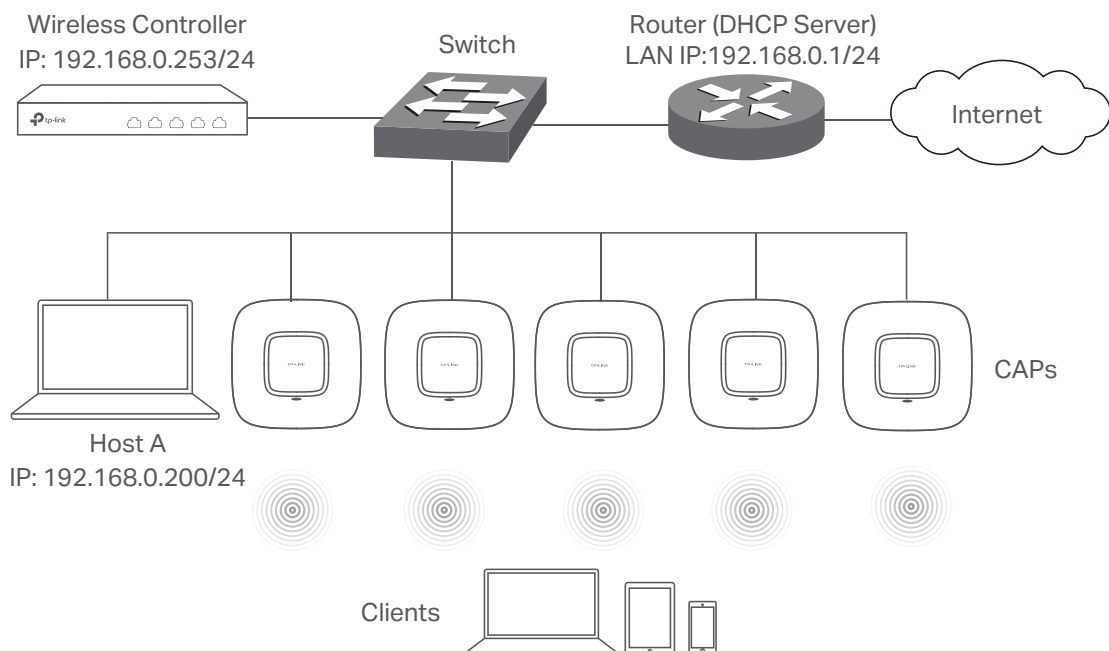

## 1.1.2 Manage CAPs in Different Network Segment

If the AC needs to manage CAPs in a different network segment, refer to the following topology.

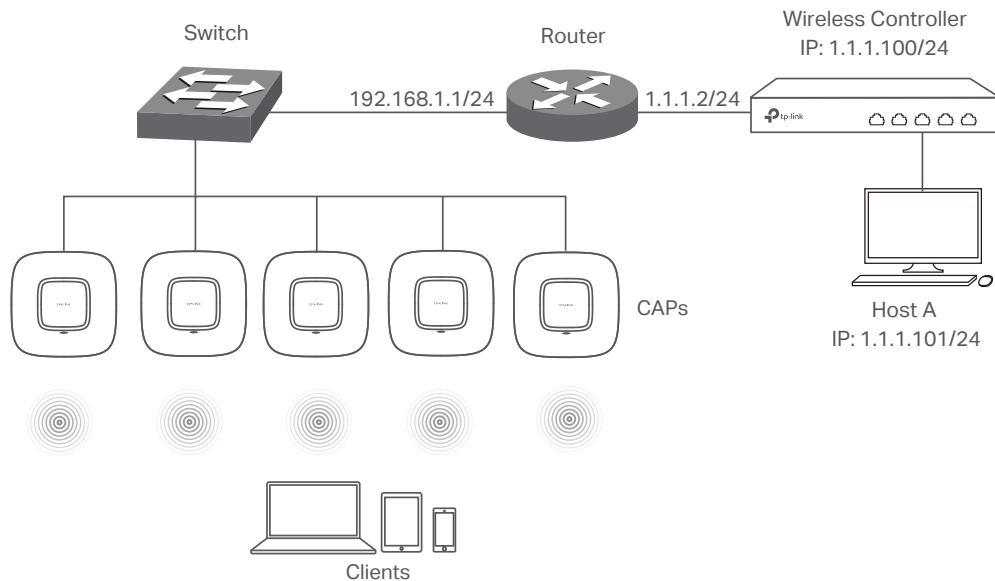

### Note:

In this situation, the router acting as the CAPs' DHCP server should support option 60 and option 138 in DHCP settings.

## 1.2 Log In to the AC

### 1.2.1 Preparations

Before login, you should verify the following items:

- The AC is powered on and correctly connected. The management host is accessible to the AC.
- Specify the management host with a static IP address on the 192.168.0.x subnet (for example, IP address 192.168.0.100 and subnet mask 255.255.255.0).
- Operating System: Microsoft Windows XP/Vista/7/8/10.
- Web Browser: Mozilla Firefox 32 (or above), Google Chrome 37 (or above), Opera 24 (or above), or Microsoft Internet Explorer 8 (or above).

## 1.2.2 Log In

- 1 Open a web browser and enter 192.168.0.253 in the address field, then press **Enter** key.

Figure 1-1 Enter the IP Address

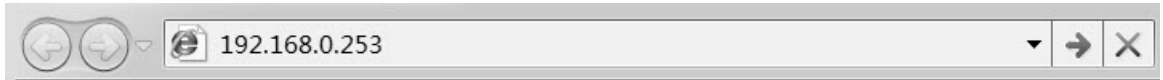

- 2 Create a username and a password for subsequent login attempts.

Figure 1-2 Create an account

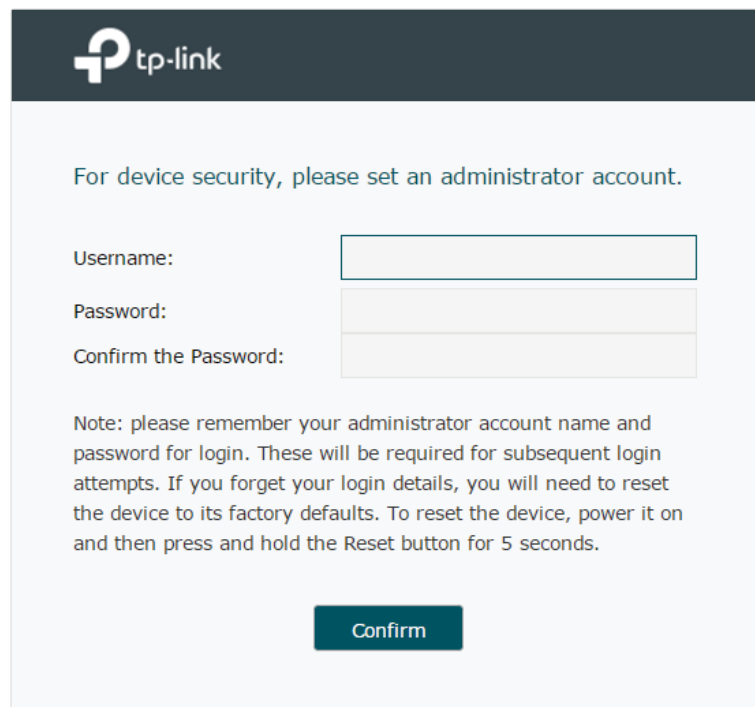
A screenshot of the TP-Link administrator account creation form. The form has a dark header with the TP-Link logo. Below the header, there is a message: "For device security, please set an administrator account." The form contains three input fields: "Username:", "Password:", and "Confirm the Password:". Below the input fields, there is a note: "Note: please remember your administrator account name and password for login. These will be required for subsequent login attempts. If you forget your login details, you will need to reset the device to its factory defaults. To reset the device, power it on and then press and hold the Reset button for 5 seconds." At the bottom of the form, there is a "Confirm" button.

tp-link

For device security, please set an administrator account.

Username:

Password:

Confirm the Password:

Note: please remember your administrator account name and password for login. These will be required for subsequent login attempts. If you forget your login details, you will need to reset the device to its factory defaults. To reset the device, power it on and then press and hold the Reset button for 5 seconds.

Confirm



- 3 Use the username and password set above to log in to the webpage.

Figure 1-3 Log in to the webpage



The image shows the login page of the TP-Link AC500 Wireless Controller. At the top left is the TP-Link logo. The main area contains two input fields: 'Username' and 'Password'. Below these fields are two buttons: 'Log In' and 'Clear'.

- 4 After a successful login, the main page will appear as in the figure below, and you can configure the function by clicking the setup menu on the left side of the screen.

Figure 1-4 Main Page

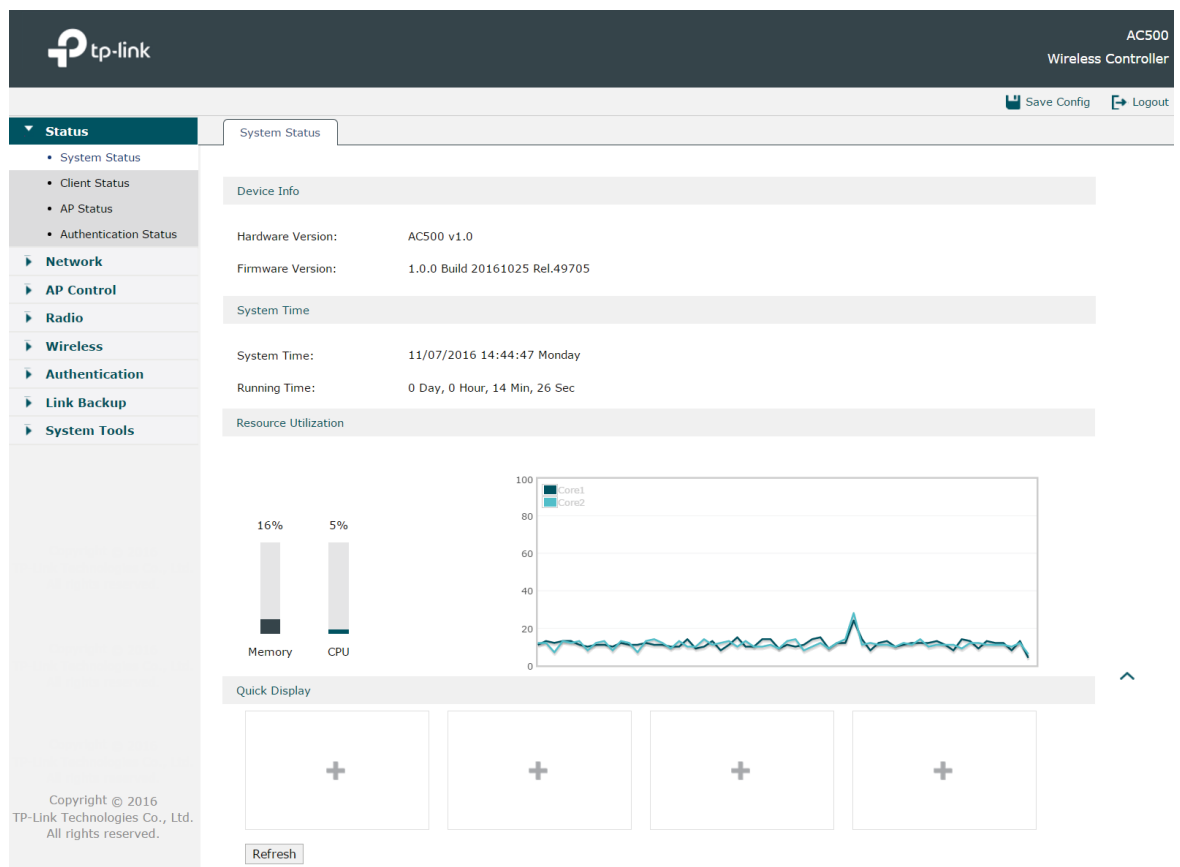

The image shows the main page of the TP-Link AC500 Wireless Controller. The page has a dark header with the TP-Link logo and 'AC500 Wireless Controller' text. Below the header is a navigation menu on the left with categories: Status, Network, AP Control, Radio, Wireless, Authentication, Link Backup, and System Tools. The main content area is titled 'System Status' and contains several sections: Device Info (Hardware Version: AC500 v1.0, Firmware Version: 1.0.0 Build 20161025 Rel.49705), System Time (System Time: 11/07/2016 14:44:47 Monday, Running Time: 0 Day, 0 Hour, 14 Min, 26 Sec), and Resource Utilization (Memory: 16%, CPU: 5%). A line graph shows resource utilization for Cors1 and Cors2. At the bottom, there is a 'Quick Display' section with four placeholder boxes and a 'Refresh' button.

The wireless controller's configuration files fall into two types: the running configuration file and the start-up configuration file. After you perform configurations on the sub-interfaces and click **Save**, the modifications will be saved in the running configuration file. However, the configurations will be lost when the device reboots.

If you need to keep the configurations even if the device reboots, please use the function to save the configurations in the start-up configuration file. Click **Save Config** on the top-right of the interface, especially before you power off or reboot the device.

# 2 Status

## 2.1 System Status

Choose the menu **Status > System Status > System Status** to load the following page.

Figure 2-1 System Status

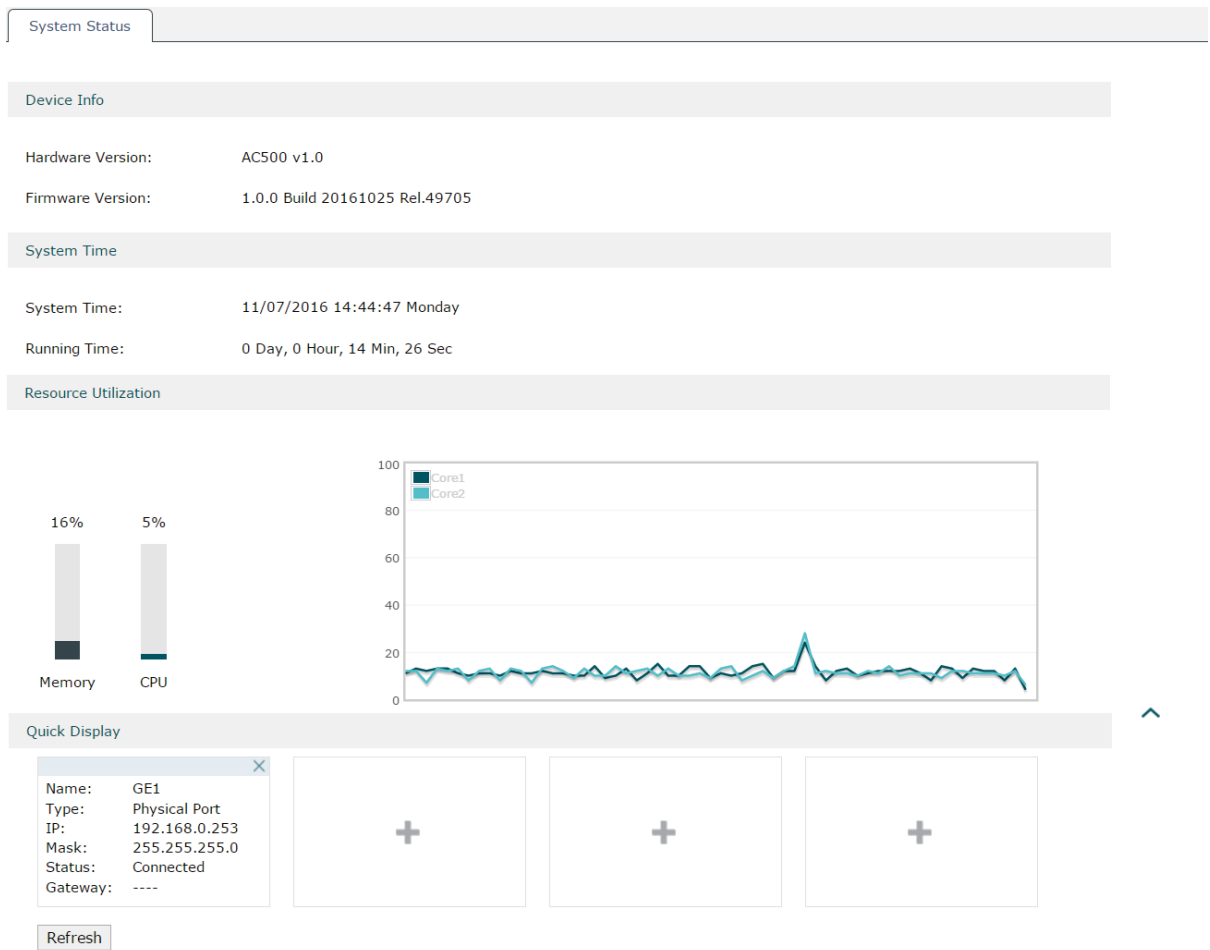

In the **Resource Utilization** section, you can monitor the utilization of the memory and CPU. It is recommended that the CPU utilization should be no more than 50%. The CPU utilization above 85% indicates that the AC is under a high load and above 95% means AC is completely loaded. When the CPU utilization keeps at high loads, some functions of the AC may be abnormal. Please check to find the real reason.

In the **Quick Display** section, click the button **+** to select the desired interface and its basic information such as interface name, type and IP address will be shown in this section.

## 2.2 Client Status

Choose the menu **Status > Client Status > Client Status** to load the following page.

Figure 2-2 Client Status

The screenshot shows the 'Client Status' page. At the top, there is a breadcrumb 'Client Status' and a help icon. Below that, a 'Select the Group:' dropdown menu is set to 'Default'. A row of action buttons includes 'Disconnect' (red minus icon), 'Search' (magnifying glass icon), 'Global Search' (magnifying glass icon), 'Refresh' (refresh icon), and 'Auto Refresh' (checkbox icon). The main table has columns for ID, MAC Address, AP Name, Radio Frequency, SSID, VLAN ID, Access Time, Signal Strength, and Operation. One client is listed with ID 1, MAC 74-1B-B2-AC-3E-B9, AP Name CAP1750-0000, Radio Frequency 2(5.0GHz), SSID Shiny, VLAN ID ---, Access Time 2016-11-09 09:19:09, and Signal Strength -61dBm. The Operation column contains a trash can icon. At the bottom right, there is a pagination bar showing 'Total 1 Items', '10 Per Page', 'Current 1/1 Page', and '1~1 Items' with navigation arrows.

You can check the information of the connected clients on this page. Select the desired clients by checking the boxes in front of the entries. Click the buttons above the list for additional operations.

Select the Group	Select the group from the drop-down list to see the clients' information in the corresponding group.
Disconnect	Disconnect one or more clients from the AP(s).
Search	Search the specified clients in the list.
Global Search	Search the specified clients globally.
Refresh	Refresh the list manually.
Auto Refresh	Check the box to enable the Auto Refresh function. With it enabled, the list will refresh every few seconds automatically.
	Disconnect the client from the AP in this corresponding entry.

## 2.3 AP Status

Choose the menu **Status > AP Status > AP Status** to load the following page.

Figure 2-3 AP Status

<input type="checkbox"/>	ID	AP Name	Model	MAC Address	IP Address	Radio List	SSID	LED	Link Status
<input type="checkbox"/>	1	CAP1750-0000	CAP1750	00-24-65-35-48-22	192.168.0.210	Detail	Detail		Master Link
<input type="checkbox"/>	2	CAP300-0001	CAP300	00-CA-0A-09-72-25	192.168.0.233	Detail	Detail		Master Link

The information of the connected CAPs will be displayed in this section. Select the desired CAPs by checking the boxes in front of the entries. Click the buttons above the list for additional operations.

Select the Group	Select the group from the drop-down list to see the CAPs' information in the corresponding group.
LED ON	Select the corresponding CAPs and click this button to turn on their LEDs.
LED OFF	Select the corresponding CAPs and click this button to turn off their LEDs. For example, if the CAP's LED disturbs you at night, you can turn off it.
Reboot	Select the corresponding CAPs and click this button to reboot them.
Search	Search the specified clients in the list.
Global Search	Search the specified clients globally.
Refresh	Refresh the list manually.
Auto Refresh	Check the box to enable the Auto Refresh function. With it enabled, the list will refresh every few seconds automatically.
	It indicates the LED is on. you can click the icon to turn off it.
	It indicates the LED is off. you can click the icon to turn on it.
	Click this icon to reboot the CAP.
Detail	Click <b>Detail</b> to check the information of the radio list and SSID and click <b>Back</b> to return.

## 2.4 Authentication Status

### 2.4.1 Authentication Status

Choose the menu **Status > Authentication Status > Authentication Status** to load the following page.

Figure 2-4 Authentication Status

The screenshot shows a web interface for 'Authentication Status'. At the top, there are two tabs: 'Authentication Status' and 'Non-sense Authenticated User'. Below the tabs is a header 'Authenticated User List' with a help icon. A toolbar contains buttons for 'Delete', 'Search', 'Global Search', 'Refresh', and 'Auto Refresh'. The main area is a table with columns: ID, Type, User Name, MAC Address, VLAN ID, Time, and Operation. The table is currently empty, showing dashes in all cells. Below the table, there is a pagination bar showing 'Total 0 Items', a dropdown menu set to '10', 'Per Page', 'Current 0/0 Page 0~0 Items', and navigation arrows.

You can check the information of the authentication status on this page. Select the desired users by checking the boxes in front of the entries. Click the buttons above the list for additional operations.

	Delete	Delete the users from the authentication list.
	Search	Search the specified users in the list.
	Global Search	Search the specified users globally.
	Refresh	Refresh the list manually.
	Auto Refresh	Check the box to enable the Auto Refresh function. With it enabled, the list will refresh every few seconds automatically.
		Disconnect the client from the AP in this corresponding entry.

## 2.4.2 Non-sense Authenticated User

A non-sense authenticated user who has passed the authentication can leave the wireless network and then join the wireless network again without any re-authentication operation.

Choose the menu **Status > Authentication Status > Non-sense Authenticated User** to load the following page.

Figure 2-5 Non-sense Authenticated User

Authentication Status > Non-sense Authenticated User

Non-sense Authenticated User ?

Delete Search Global Search Refresh Auto Refresh

<input type="checkbox"/>	ID	VLAN ID	MAC Address	User Name	Password	Time	Operation
--	--	--	--	--	--	--	--

Total 0 Items, 10 Per Page | Current 0/0 Page 0~0 Items

You can check the information of the non-sense authenticated users on this page. Select the desired users by checking the box in the front of the entries. Click the buttons above the list for additional operations.

	Delete	Delete the users from the authentication list.
	Search	Search the specified users in the list.
	Global Search	Search the specified users globally.
	Refresh	Refresh the list manually.
<input type="checkbox"/>	Auto Refresh	Check the box to enable the Auto Refresh function. With it enabled, the list will refresh every few seconds automatically.
		Disconnect the client from the AP in this corresponding entry.

# 3 Network

## 3.1 Interface

Choose the menu **Network > Interface > Interface** to load the following page. On this page you can create a logical interface and specify it to a specified VLAN. Please refer to [3.3.1 VLAN](#) to set VLANs first.

Figure 3-1 Interface

The screenshot shows the 'Interface Settings' page. At the top, there is a breadcrumb 'Interface' and a 'Interface Settings' header with a help icon. Below the header are three action buttons: '+ Add', '- Delete', and 'Search'. The main content is a table with the following data:

<input type="checkbox"/>	ID	Interface Name	Connection Status	VLAN	IP Address	Subnet Mask	Default Gateway	Operation
<input type="checkbox"/>	1	GE1	Connected <a href="#">Detail</a>	---	192.168.0.25	255.255.255.0	---	<a href="#">Edit</a>
<input type="checkbox"/>	2	Market	Connected <a href="#">Detail</a>	5	192.168.2.101	255.255.255.0	---	<a href="#">Edit</a> <a href="#">Delete</a>
<input type="checkbox"/>	3	RDdepartment	Connected <a href="#">Detail</a>	4	192.168.1.104	255.255.255.0	---	<a href="#">Edit</a> <a href="#">Delete</a>

At the bottom of the table, there is a pagination control: 'Total 3 Items, 10 Per Page | Current 1/1 Page 1~3 Items |' with navigation arrows and the number '1'.

Click **+ Add** to create a new interface. The page will be shown as below.

Figure 3-2 Add an Interface

The screenshot shows the 'Add an Interface' form with the following fields and values:

- Interface Name:  (1-12 letters, digits or underscores)
- VLAN:  (dropdown menu)
- Connection Type:  (dropdown menu)
- IP Address:
- Subnet Mask:
- Default Gateway:  (Optional)
- MTU:  (576-1500)
- Primary DNS:  (Optional)
- Secondary DNS:  (Optional)
- MAC Address:
- Description:  (1-50 characters, optional)

At the bottom of the form are two buttons: 'OK' and 'Cancel'.

**Interface Name** Specify a name for the interface to make it easier to search for and manage.

**VLAN** Specify a VLAN for the interface.



Connection Type	Select the connection type for the interface. Only static IP is supported at present.
IP Address	Specify an IP address for the interface.
Subnet Mask	Specify a subnet mask for the interface.
Default Gateway	(Optional) Specify a default gateway for the interface.
MTU	Specify the MTU (Maximum Transmission Unit) for the interface. Its value is between 576 to 1500 and 1500 by default.
Primary DNS	(Optional) Specify the primary DNS server for the interface.
Secondary DNS	(Optional) Specify the secondary DNS server for the interface.
MAC Address	The MAC address is filled automatically. You can modify it manually.
Description	Specify a description for the entry to make it easier to search for and manage.

Click **OK** to finish the settings.

## 3.2 DHCP Server

### 3.2.1 DHCP Server

Choose the menu **Network > DHCP Server > DHCP Server** to load the following page.

Figure 3-3 DHCP Server

DHCP Server | DHCP Client List | Address Reservation

Global Settings ?

Target:  For AP Only  For AP and Client

Save

DHCP Server List

Enable 
  Disable 
  Add 
  Delete 
  Search

<input type="checkbox"/>	ID	Interface	Starting IP Address	Ending IP Address	Lease Time	Default Gateway	Primary DNS	Status	Operation
<input type="checkbox"/>	1	GE1	192.168.0.1	192.168.0.254	120	---	---	Enabled <input checked="" type="checkbox"/>	<input type="checkbox"/> <input type="checkbox"/>

Total 1 Items. 10 Per Page | Current 1/1 Page 1~1 Items |

DHCP (Dynamic Host Configuration Protocol) allows the wireless controller to assign IP addresses, subnet masks, default gateways and other IP parameters to CAPs and clients that request this information. In the global settings you can select that the DHCP server assigns IP parameters to AP only or both AP and client.

Click **+** **Add** to create a DHCP server. The page will be shown as below.

Figure 3-4 Add a DHCP Server

Interface:	RDdepartment	
Starting IP Address:	192.168.1.20	
Ending IP Address:	192.168.1.251	
Lease Time:	120	minutes. (2-2880. The default value is 120)
Default Gateway:		(Optional)
Default Domain:		(Optional)
Primary DNS:		(Optional)
Secondary DNS:		(Optional)
Status:	<input checked="" type="checkbox"/> Enable	
<input type="button" value="OK"/> <input type="button" value="Cancel"/>		

<b>Interface</b>	Select the interface which you want to create the DHCP server for. Refer to <a href="#">3.1 Interface</a> to set the interface first.
<b>Starting/Ending IP Address</b>	Specify the starting IP address and ending IP address of the DHCP server IP pool. The IP pool should be in the same segment with the interface IP address.
<b>Lease Time</b>	Enter the time duration of the IP address assigned by the DHCP server between 2 and 2880 minutes. The default is 120 minutes. Before the time is up, DHCP server would not assign this IP address to other APs or clients.
<b>Default Gateway</b>	Optional: Specify the IP address of gateway for the server.
<b>Default Domain</b>	Optional: Specify the domain of for the server.
<b>Primary DNS</b>	Optional: Specify the primary DNS server for the server.
<b>Secondary DNS</b>	Optional: Specify the secondary DNS server for the server.
<b>Status</b>	Check the box to enable the DHCP service.

Click **OK** to finish the settings.

### 3.2.2 DHCP Client List

Choose the menu **Network > DHCP Server > DHCP Client List** to load the following page. The list displays the information such as the IP address, MAC address and lease time of the connected clients.

Figure 3-5 DHCP Client List

ID	Interface	Client Name	MAC Address	Assigned IP Address	Lease Time
1	GE1	CAP300-00-CA-0A-09-72-25	00-CA-0A-09-72-25	192.168.0.233	01:38:46
2	GE1	CAP300-Outdoor-00-14-78-87-43-96	00-14-78-87-43-96	192.168.0.225	01:20:24

### 3.2.3 Address Reservation

Choose the menu **Network > DHCP Server > Address Reservation** to load the following page.

Figure 3-6 Address Reservation

<input type="checkbox"/>	ID	Interface	MAC Address	IP Address	Description	Status	Operation
--	--	--	--	--	--	--	--

If the CAP or client requires a static IP address, you can manually reserve an IP address for it. Once reserved, the IP address will only be assigned to the same client by the DHCP server.

Click  **Add** to create an IP address reservation.

Figure 3-7 Create an IP Address Reservation

Interface:

MAC Address:

IP Address:

Description:  (1-32 characters, optional)

Status:  Enable

<b>Interface</b>	Select the interface which the CAP or client requiring the static IP address belongs to. Refer to <a href="#">3.1 Interface</a> to set the interface first.
<b>MAC Address</b>	Enter the MAC address of the specified AP or client to which you want to assign the static IP address.
<b>IP Address</b>	Specify a static IP address to the specified AP or client. The IP address should be in the same segment as the interface.
<b>Description</b>	Specify a description for the entry to make it easier to search for and manage.
<b>Status</b>	Check the box to enable the address reservation.

Click **OK** to finish the settings.

## 3.3 VLAN

### 3.3.1 VLAN

Choose the menu **Network > VLAN > VLAN** to load the following page.

Figure 3-8 VLAN

VLAN
Ports
Relations

VLAN List
?

+ Add - Delete 🔍 Search

<input type="checkbox"/>	ID	VLAN ID	Name	Ports	Description	Operation
--	1	1	vlan1	1(UNTAG) 2(TAG) 4(UNTAG) 5(UNTAG)	system vlan	
<input type="checkbox"/>	2	4	general	1(TAG)	---	
<input type="checkbox"/>	3	5	Market VLAN	1(UNTAG) 2(TAG) 3(UNTAG)	market	

Total 3 Items. 10 Per Page | Current 1/1 Page 1~3 Items |
 
 1

VLAN (Virtual Local Area Network) is a network technique that solves broadcasting issues in local area networks. A local area network is partitioned into several VLANs, and all VLAN traffic remains within its VLAN. Therefore, you can group and isolate APs and clients to enhance network security. VLANs group devices logically instead of physically, so devices in the same VLAN can be located in different places.

Click  **Add** to create a VLAN.

Figure 3-9 Create a VLAN

Port	Link Type	TAG
<input checked="" type="checkbox"/> 1	General	UNTAG
<input type="checkbox"/> 2	Trunk	TAG
<input type="checkbox"/> 3	Trunk	TAG
<input type="checkbox"/> 4	Trunk	TAG
<input type="checkbox"/> 5	Access	UNTAG

<b>VLAN ID</b>	Specify a VLAN ID between 2 to 4094.
<b>Name</b>	Specify an easy-to-remember name for the VLAN.
<b>Ports</b>	Select the ports that belong to the VLAN.
<b>Description</b>	Specify a description for the entry to make it easier to search for and manage.

Click **OK** to finish the settings.

## 3.3.2 Ports

Choose the menu **Network > VLAN > Ports** to load the following page. Specify the link type and PVID for each port. The link type and PVID can not be modified at the same time.

Figure 3-10 Ports

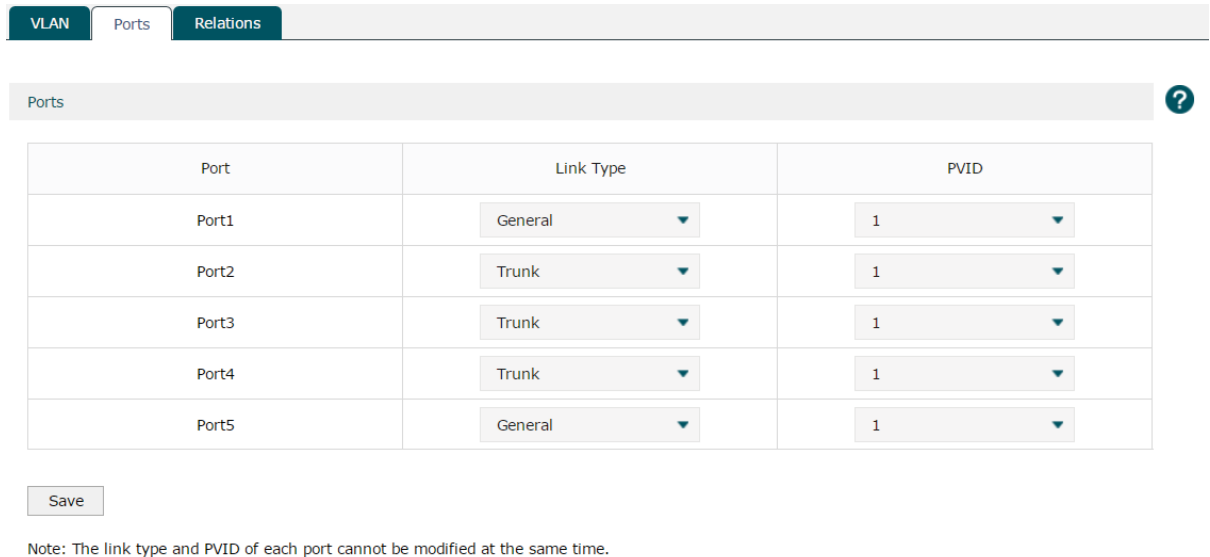

Port	Link Type	PVID
Port1	General	1
Port2	Trunk	1
Port3	Trunk	1
Port4	Trunk	1
Port5	General	1

Save

Note: The link type and PVID of each port cannot be modified at the same time.

### Link Type

The ports can be divided into three link types:

**Access:** The access port can be added in a single VLAN, and the egress rule of the port is UNTAG. The PVID is same as the current VLAN ID. If the current VLAN is deleted, the PVID will be set to 1 by default.

**Trunk:** The trunk port can be added in multiple VLANs. The egress rule of the port is UNTAG if the arriving packet's VLAN tag is the same as the port's PVID, otherwise the egress rule is TAG. The PVID can be set as the VID number of any valid VLAN.

**General:** The general port can be added in multiple VLANs and set various egress rules according to the different VLANs. The default egress rule is UNTAG. The PVID can be set as the VID number of any valid VLAN.

### PVID

Enter the VLAN ID of the port.

### Note:

AC50 doesn't include a General port link type.

### 3.3.3 Relations

Choose the menu **Network > VLAN > Relations** to load the following page. This list displays the relations among ports, link types and VLANs.

Figure 3-11 Relations

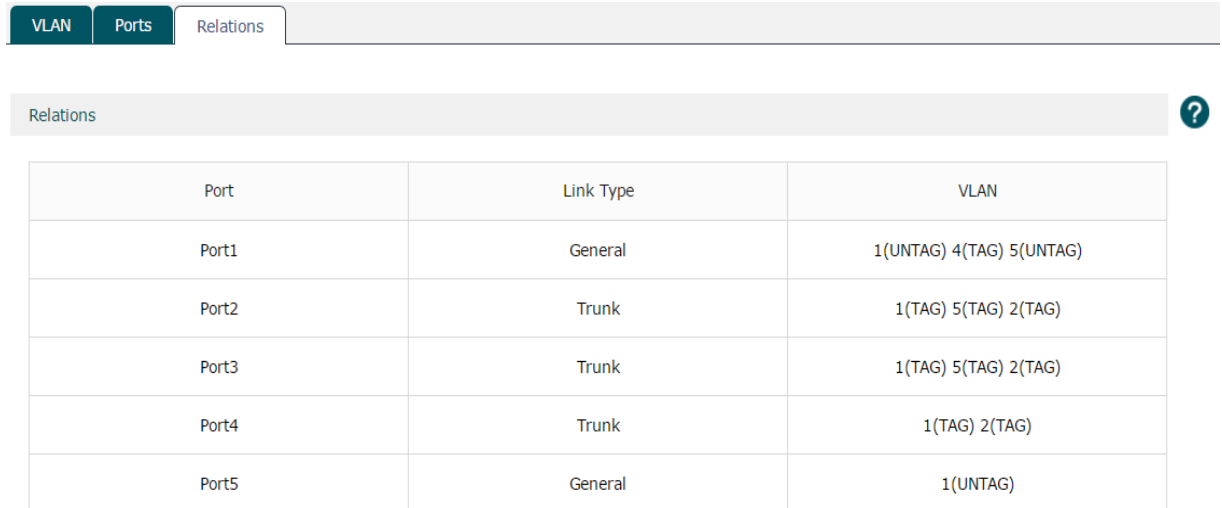

Port	Link Type	VLAN
Port1	General	1(UNTAG) 4(TAG) 5(UNTAG)
Port2	Trunk	1(TAG) 5(TAG) 2(TAG)
Port3	Trunk	1(TAG) 5(TAG) 2(TAG)
Port4	Trunk	1(TAG) 2(TAG)
Port5	General	1(UNTAG)

## 3.4 Switch

### 3.4.1 Statistics

Choose the menu **Network > Switch > Statistics** to load the following page. The statistics list displays the information of data packets received or transmitted by each port.

Figure 3-12 Statistics

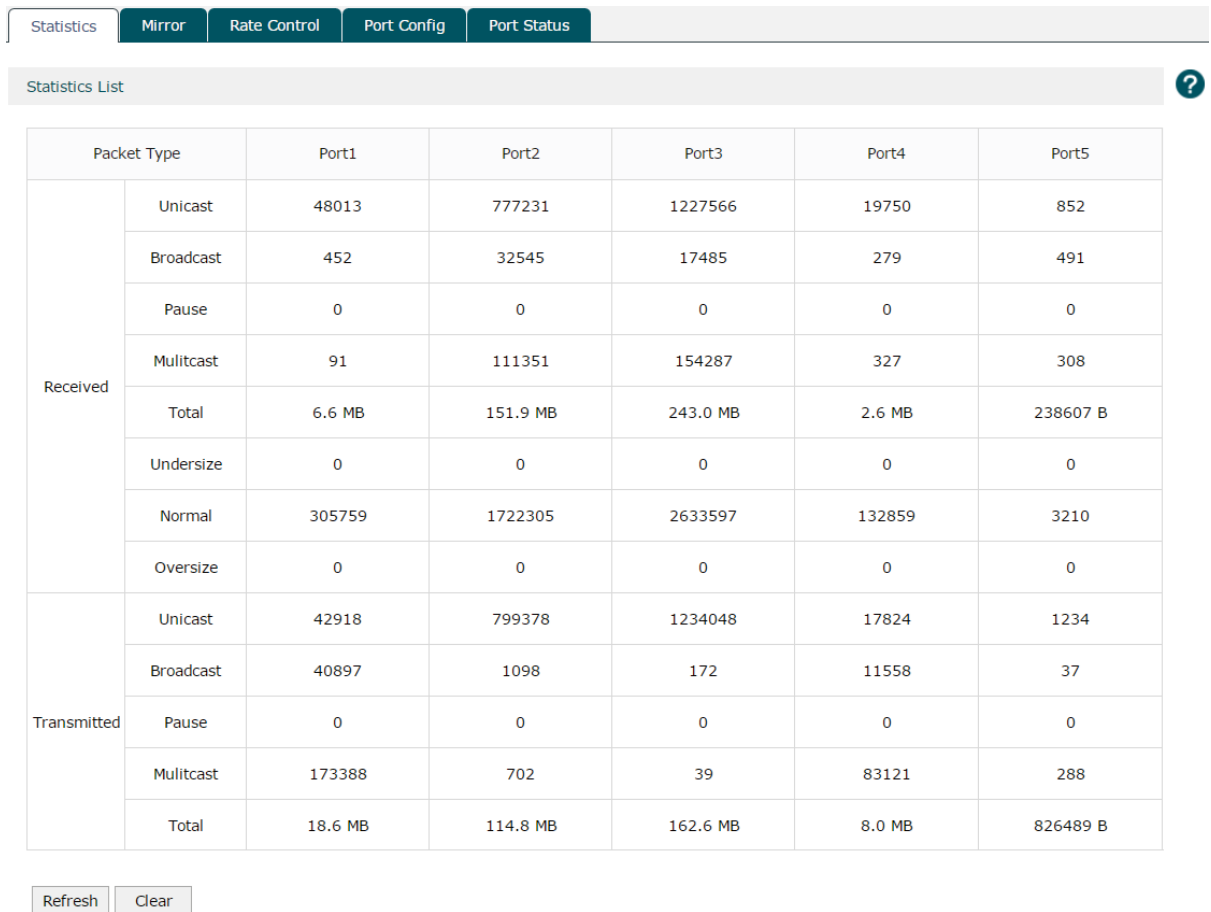

The screenshot shows a web interface for switch statistics. At the top, there is a navigation menu with tabs: Statistics (selected), Mirror, Rate Control, Port Config, and Port Status. Below the menu is a header for the 'Statistics List' with a help icon. The main content is a table with columns for Packet Type, Port1, Port2, Port3, Port4, and Port5. The table is divided into two sections: 'Received' and 'Transmitted'. Each section lists various packet types and their counts/bytes across the five ports. At the bottom of the table, there are 'Refresh' and 'Clear' buttons.

Packet Type		Port1	Port2	Port3	Port4	Port5
Received	Unicast	48013	777231	1227566	19750	852
	Broadcast	452	32545	17485	279	491
	Pause	0	0	0	0	0
	Multicast	91	111351	154287	327	308
	Total	6.6 MB	151.9 MB	243.0 MB	2.6 MB	238607 B
	Undersize	0	0	0	0	0
	Normal	305759	1722305	2633597	132859	3210
	Oversize	0	0	0	0	0
Transmitted	Unicast	42918	799378	1234048	17824	1234
	Broadcast	40897	1098	172	11558	37
	Pause	0	0	0	0	0
	Multicast	173388	702	39	83121	288
	Total	18.6 MB	114.8 MB	162.6 MB	8.0 MB	826489 B

Refresh Clear



## 3.4.2 Mirror

Choose the menu **Network > Switch > Mirror** to load the following page.

Figure 3-13 Mirror

Mirroring Port	Mirrored Port
<input type="radio"/> Port1	<input checked="" type="checkbox"/> Port1
<input type="radio"/> Port2	<input type="checkbox"/> Port2
<input type="radio"/> Port3	<input type="checkbox"/> Port3
<input type="radio"/> Port4	<input type="checkbox"/> Port4
<input checked="" type="radio"/> Port5	<input type="checkbox"/> Port5

Check the box to enable the Port Mirror function. There are three port mirror modes as follows.

**Ingress and egress:** When this mode is selected, both the incoming and outgoing packets through the mirrored port will be copied to the mirroring port.

**Ingress:** When this mode is selected, the incoming packets received by the mirrored port will be copied to the mirroring port.

**Egress:** When this mode is selected, the outgoing packets sent by the mirrored port will be copied to the mirroring port.

A port cannot be set as the mirrored port and the mirroring port simultaneously. Only one mirroring port can be set.

## 3.4.3 Rate Control

Choose the menu **Network > Switch > Rate Control** to load the following page. Here you can control the data transfer rate for each port. Check boxes to manually enter the corresponding rates.

### Note:

The data transfer rate ranges from 1 to 100Mbps for AC50, and from 1 to 1000Mbps for AC500.

Figure 3-14 Rate Control

Port	Ingress Limit	Ingress Rate(Mbps)	Egress Limit	Egress Rate(Mbps)
Port1	<input type="checkbox"/> Enable	1000	<input type="checkbox"/> Enable	1000
Port2	<input type="checkbox"/> Enable	1000	<input type="checkbox"/> Enable	1000
Port3	<input type="checkbox"/> Enable	1000	<input type="checkbox"/> Enable	1000
Port4	<input type="checkbox"/> Enable	1000	<input type="checkbox"/> Enable	1000
Port5	<input type="checkbox"/> Enable	1000	<input type="checkbox"/> Enable	1000

Save Refresh

Click **Save** to finish the settings.

### 3.4.4 Port Config

Choose the menu **Network > Switch > Port Config** to load the following page.

Figure 3-15 Port Cofig

Port	Flow Control	Negotiation Mode
Port1	<input type="checkbox"/> Enable	Auto
Port2	<input type="checkbox"/> Enable	Auto
Port3	<input type="checkbox"/> Enable	Auto
Port4	<input type="checkbox"/> Enable	Auto
Port5	<input type="checkbox"/> Enable	Auto

Save

#### Flow Control

With this option enabled, the device synchronizes the data transmission speed with the peer device, thus avoiding the packet loss caused by congestion. By default, it is disabled.

#### Negotiation Mode

Select the Negotiation Mode for the port including auto and duplex mode. Duplex mode includes 10M Half-duplex, 10M Full-duplex, 100M Half-duplex, 100M Full-duplex and 1000M Full-duplex.

#### Note:

The AC50 doesn't support 1000M Full-duplex.

### 3.4.5 Port Status

Choose the menu **Network > Switch > Port Status** to load the following page.

Figure 3-16 Port Status

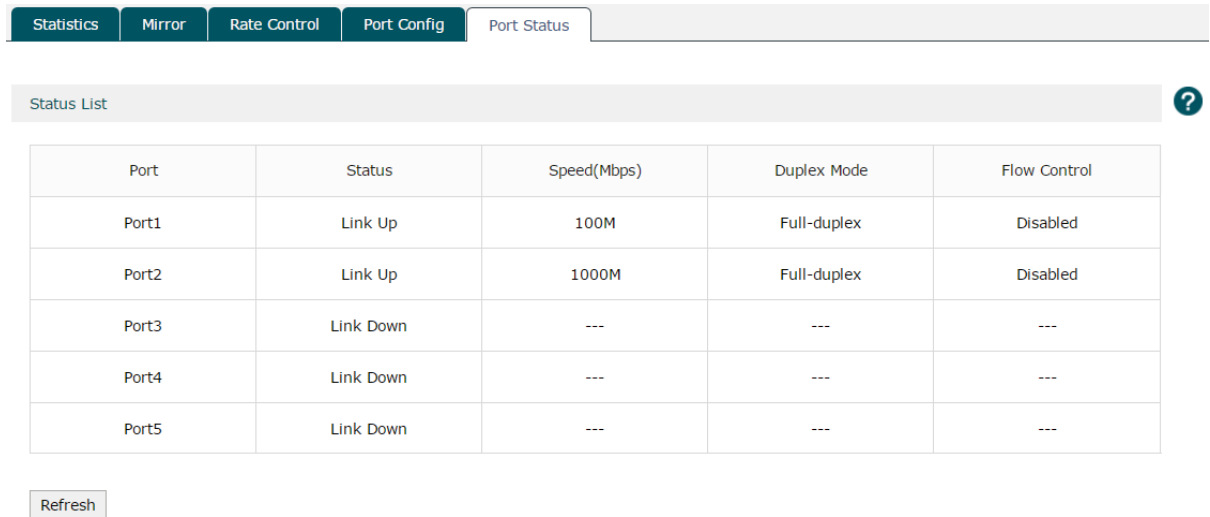

Port	Status	Speed(Mbps)	Duplex Mode	Flow Control
Port1	Link Up	100M	Full-duplex	Disabled
Port2	Link Up	1000M	Full-duplex	Disabled
Port3	Link Down	---	---	---
Port4	Link Down	---	---	---
Port5	Link Down	---	---	---

Refresh

This page displays the connection status, speed, duplex mode and flow control status of each port.

**Disabled:** The port is disabled.

**Link down:** The port is enabled but with physical connection.

**Link up:** The Port is enabled and connected normally.

**Note:**

The data transfer rate ranges from 1 to 100Mbps for AC50, and from 1 to 1000Mbps for AC500. AC50 doesn't support 1000M Full-duplex.

# 4 AP Control

## 4.1 AP Settings

Choose the menu **AP Control > AP Settings > AP Settings** to load the following page.

Figure 4-1 AP Settings

AP Settings

Global Settings ?

Reboot Schedule

Reboot Date : Everyday

Reboot Time: 00 : 00 : 00 (HH/MM/SS)

Lock to AC Automatically

Save

Group List

+ Add - Delete 🔍 Search 🌐 Global Search 🔄 Refresh  Auto Refresh

<input type="checkbox"/>	ID	Group Name	Group Statistics Information	Operation
--	1	Default(Default Group)	<a href="#">1/2,0</a>	

Total 1 Items, 10 Per Page | Current 1/1 Page 1~1 Items | ⏪ 1 ⏩

In the global settings, check the Reboot Schedule box and then the Lock to AC Automatically box to enable the corresponding function. Click **Save** to complete.

<b>Reboot Schedule</b>	With the reboot schedule enabled, all connected APs will reboot at the specified time.
<b>Reboot Date</b>	Select the date to reboot the APs. If you want to reboot the APs everyday, please select everyday in the list.
<b>Reboot Time</b>	Specify the reboot time to reboot the APs in the format of HH/MM/SS.
<b>Lock to AC Automatically</b>	With the lock to AC automatically enabled, all the APs entries will be locked to AC automatically once APs connect to the AC. The unlocked AP entries will disappear when the AC reboots.

Click + Add to create a new group. The following figure will be shown. Specify a group name in the field and click **OK**.

Figure 4-2 Add a group

--	--	--	--
Group Name: <input type="text"/> (1-32 characters)			
<input type="button" value="OK"/>		<input type="button" value="Cancel"/>	

In the group list, click the numbers at the Group Statistics Information row. The group information will be shown as below. Click the buttons above the list for additional operations.

Figure 4-3 Group statistics information

'Default' Group List

[Back to Group List](#)
[Move to Other Group](#)
[Lock to AC](#)
[Add](#)
[Delete](#)
[Bulk Edit](#)
[Search](#)
[Intra-Group Search](#)
[Refresh](#)

<input type="checkbox"/>	ID	Name	Model	Hardware Version	Firmware Version	MAC Address	Status	Operation
<input type="checkbox"/>	1	CAP1750-0000	CAP1750	1.0	---	00-24-65-35-48-22	Unconnected	
<input type="checkbox"/>	2	CAP300-0001	CAP300	1.0	1.0.0	00-CA-0A-09-72-25	Operation	

Total 2 Items,  Per Page | Current 1/1 Page 1~2 Items | 1

<b>Back to Group List</b>	Click this button to return to the group list.
<b>Move to Other Group</b>	Select the corresponding entries and click this button to move them to your desired group.
<b>Lock to AC</b>	Select the corresponding entries and click this button to lock the APs to the AC.
<b>Bulk Edit</b>	Select the corresponding entries and click this button to bulk edit the APs' AP keep-alive time, client keep-alive time and client idle time. Refer to the following introduction below the table for details.
<b>Search</b>	Click this button to search the specified AP(s) on the current page.
<b>Intra Group Search</b>	Click this button to search the specified AP(s) in all the AP entries without the limitation of groups.

Click  at the Operation row of the list. The following figure will be shown.

Figure 4-4 AP Settings

-	2	CAP300-0001	CAP300	1.0	1.0.0	00-CA-0A-09-72-25	Operation	---
---	---	-------------	--------	-----	-------	-------------------	-----------	-----

Name:	<input type="text" value="CAP300-0001"/>	(1-50 characters)
AP Keep-alive Time:	<input type="text" value="30"/>	(20-80 seconds)
Client Keep-alive Time:	<input type="text" value="10"/>	(3-1800 seconds)
Client Idle Time:	<input type="text" value="3600"/>	(60-86400 seconds)

<b>Name</b>	Specify the AP's name.
<b>AP Keep-alive Time</b>	Specify the time interval for the AP sending echo packets to the AC. AC can detect whether the AP is online or not by receiving the echo packets.
<b>Client Keep-alive Time</b>	Specify the time interval for the client sending heartbeat packets to the AP. APs can detect whether the client is online or not by receiving heartbeat packets.
<b>Client Idle Time</b>	Specify a time interval for the client idle time. The clients will be disconnected from the AP if there is no data transmission between AP and clients for the specific time interval.

## 4.2 AP Firmware Upgrade

Choose the menu **AP Control > AP Firmware Upgrade > AP Firmware Upgrade** to load the following page.

With it enabled, import the correct firmwares and set the starting upgrade time. The connected APs will start to upgrade at the specified time. If it is disabled, the APs that haven't started upgrading will not be upgraded.

Figure 4-5 AP Firmware Upgrade

AP Firmware Upgrade

Upgrade Settings ?

Upgrade:  Enable  Disable

Save

Version List

Search Refresh

ID	AP Model	Hardware Version	Firmware Version	Upgrade Starting Time	Upgrade Process	Upgrade Failure	Upgrade Status	Operation
1	CAP300	1.0	---	---	---	---	---	Import Delete
2	CAP1750	1.0	---	---	---	---	---	Import Delete
3	CAP300-OUTDOOR	1.0	---	---	---	---	---	Import Delete

Total 3 Items. 10 Per Page | Current 1/1 Page 1~3 Items | 1

<b>AP Model</b>	Displays the AP model.
<b>Hardware Version</b>	Displays the current hardware version.
<b>Firmware Version</b>	Displays the imported firmware version.
<b>Upgrade Starting Time</b>	After the upgrade file has been imported successfully, specify the upgrade starting time. With upgrade enabled, the APs of this model will automatically upgrade using the upgrade file.
<b>Upgrade Process</b>	Displays the upgrade process. The format is X/Y/Z, which means there are Z APs of this model in the system, with Y APs waiting to upgrade and X APs have upgraded successfully. Click the numbers to check each AP's upgrade status.
<b>Upgrade Failure</b>	Displays the number of APs which failed to upgrade. Click the number to check the detailed log information.

<b>Upgrade Status</b>	<p>Displays the upgrade status of current APs of this model. Click to check the detailed upgrade information of each AP of this model.</p> <p><b>Latest:</b> There is no AP of the current model to be upgraded.</p> <p><b>Waiting:</b> APs of the current model are waiting to be upgraded.</p> <p><b>Upgrading:</b> Some APs of the current model are upgrading.</p> <p><b>Completed:</b> All APs of the current model are upgraded.</p> <p><b>Terminated:</b> The upgrade was disabled while the AP was waiting to upgrade. The AP's upgrade process is terminated. When the upgrade is enabled again, the status of the AP will change to "Waiting".</p>
<b>Operation</b>	<p>Click <b>Import</b> to import the upgrade firmware into the system.</p> <p>Click <b>Delete</b> to delete the firmware.</p>

**Note:**

1. Only one model can upgrade at a time.
2. When the AC reboots or the CAPs reboot automatically, the CAPs can only upgrade after ten minutes.
3. The parameter of upgrade process and upgrade failure will be cleared when the AC reboots.
4. The standby link doesn't support upgrade schedule.

### 4.3 AP Database

Import the AP database file to support the identification and management of new AP models on this page. When there is an undetected AP model connecting to the AC, the AC should import the latest AP database to identify the new AP models.

Choose the menu **AP Control > AP Database > AP Database** to load the following page.

Figure 4-6 AP Settings

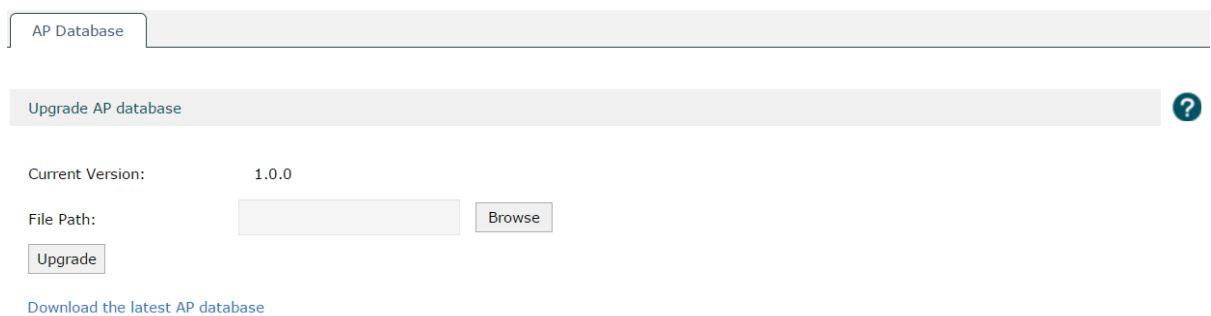

<b>Current Version</b>	Displays the current version of the AP database.
<b>File Path</b>	Click <b>Browse</b> to locate and select the new AP database. Click <b>Upgrade</b> to import it.
<b>Download the latest AP database</b>	Click <b>Download the latest AP database</b> . You will be redirected to the TP-Link download center to download the AP database files. The download center will update the AP database file.



## 4.4 Load Balancing

Load Balancing is applied in the high density wireless environment. It can balance the APs load and guarantee the reasonable access of the clients to APs. Therefore, the wireless resources and bandwidth of each AP can be used fairly.

The following example is used to illustrate the working process of load balancing.

Figure 4-7 Topology

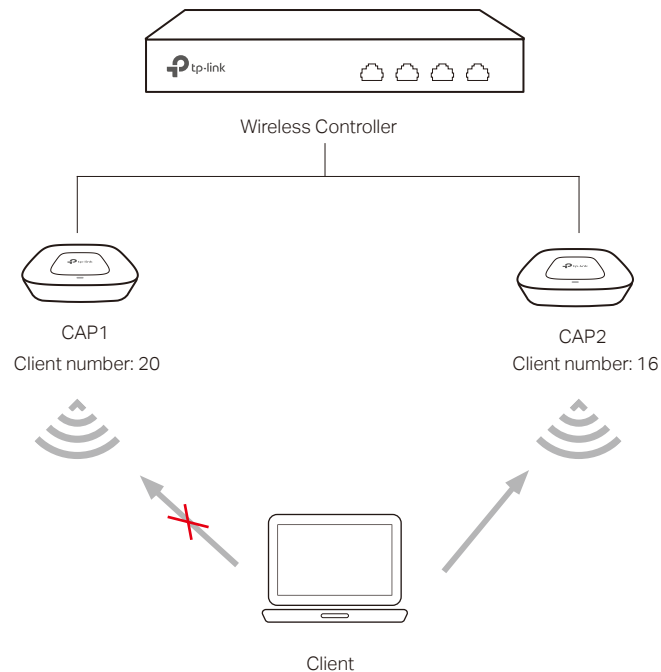

The client is within the wireless range of CAP1 and CAP2. The client requests to connect to CAP1 and the following two conditions are met:

- 1 The client number of CAP1 has reached or exceeded the maximum number that the load balancing set ( 20 as an example).
- 2 The client is also in the coverage of other CAPs. And the difference of the connected client number between CAP1 and one of the other CAPs is greater than the difference threshold set in load balancing (4 as an example,  $20-16 \geq 4$ ).

Due to load balancing, AC will reject the client's request to connect to CAP1 and instead connect the client to other CAPs with a smaller load. Thus, the performance of the whole network is improved.

If the client requests to connect to CAP1 continually, and the request fail number exceeds the maximum fail number set in load balancing, CAP1 will accept the connecting request of the client.

If the signal strength of the client is smaller than the RSSI threshold, it will not count to the total number of clients in load balancing.

Choose the menu **AP Control > Load Balancing > Load Balancing** to load the following page.

Figure 4-8 Load Balancing

Load Balancing

Function ?

Load Balancing:  Enable  Disable

Load Balancing Settings

Mode: Session ▼

Threshold: 20 (2-40, 20 by default)

Difference Threshold: 4 (1-8, 4 by default)

Maximum Fail Number: 10 (1-100, 10 by default)

RSSI Threshold: -75 (-95-0, -75 by default)

Save

<b>Load Balancing</b>	Specify whether to enable load balancing.
<b>Mode</b>	Load balancing supports session mode only at present. In this mode, each AP will be assigned an average number of clients by the AC.
<b>Threshold</b>	Set the maximum number of clients that are allowed to access the AP. The client's request to connect to the CAP will be rejected when the threshold and difference threshold are exceeded.
<b>Difference Threshold</b>	Set the maximum difference between the number of clients connected to the AP with the number of clients connected to other APs. The client's requests to connect will be rejected when the threshold and difference threshold are exceeded.
<b>Maximum Fail Number</b>	Set the maximum fail number for the client's connection request. When the client's connection requests fail more than the specified number, the AP will allow it to connect.
<b>RSSI Threshold</b>	Specify the RSSI (Received Signal Strength Indicator) threshold. If the signal strength of the client is lower than the RSSI threshold, it will not count to the total number of clients for the purpose of load balancing.

# 5 Radio

## 5.1 Radio Settings

Choose the menu **Radio > Radio Settings > Radio Settings** to load the following page.

Figure 5-1 Radio Settings

Radio List

Select the Group: Default

Enable  Disable  Bulk Edit  Search  Global Search

<input type="checkbox"/>	ID	AP Name	Radio Frequency	Mode	Channel	Bandwidth	Transmit Power	Maximum Users	Status	Operation
<input type="checkbox"/>	1	q1	1(2.4GHz)	802.11b/g/n	3	Auto	Auto	100	Enabled <input checked="" type="checkbox"/>	<input checked="" type="checkbox"/>
<input type="checkbox"/>	2	q1	2(5.0GHz)	802.11a/n/ac	Auto	Auto	Auto	100	Enabled <input checked="" type="checkbox"/>	<input checked="" type="checkbox"/>
<input type="checkbox"/>	3	q2	1(2.4GHz)	802.11b/g/n	Auto	Auto	Auto	100	Enabled <input checked="" type="checkbox"/>	<input checked="" type="checkbox"/>
<input type="checkbox"/>	4	q2	2(5.0GHz)	802.11a/n/ac	Auto	40MHz	Auto	100	Enabled <input checked="" type="checkbox"/>	<input checked="" type="checkbox"/>

Total 4 Items , 10 Per Page | Current 1/1 Page 1~4 Items | 1

On this page, you can specify the radio parameters of multiple or individual CAPs. Select the entries and click the buttons above the list to change the radio status or bulk edit the parameters.

Click  at the operation row in the radio list, the following figure will be shown.

Figure 5-2 Change the Radio Settings

--	1	q1	1(2.4GHz)	802.11b/g/n	3	Auto	Auto	100	Enabled	---
----	---	----	-----------	-------------	---	------	------	-----	---------	-----

AP Name:  (1-50 characters)

Radio Frequency:

Mode:  ▼

Bandwidth:  ▼

Channel:  ▼

Transmit Power:

Maximum Users:  (1-100 users)

Antenna:  ▼

Fragment Threshold:  (Only even numbers are allowed, 256-2346 bytes)

Beacon Interval:  (40-1000 TU)

Airtime Fairness:  Enabled  Disabled

RTS Threshold:  (1-2347 bytes)

DTIM Period:  (1-255)

WMM:  Enable  Disable

Broadcast Probe Response:  Enable  Disable

Short GI:  Enable  Disable

Weak Signal Forbidden:  Enable  Disable Forbid stations with a signal strength lower than  dBm from accessing the AP. (-95-0)

Weak Signal Discard:  Enable  Disable Discard stations with a signal strength lower than  dBm. (-95-0)

<b>AP Name</b>	Displays the name of the AP.
<b>Radio Frequency</b>	Displays the radio frequency of the AP to be modified.
<b>Mode</b>	Specify the working mode of the wireless network. AP with a frequency band of 2.4GHz supports five wireless modes: 802.11b, 802.11g, 802.11n, 802.11b/g, 802.11g/n and 802.11b/g/n. You are recommended to select the 11b/g/n mode, and all of 802.11b, 802.11g and 802.11n wireless stations can connect to the AP. AP with a frequency band of 5GHz supports 802.11a, 802.11n, 802.11ac, 802.11a/n, 802.11n/ac and 802.11a/n/ac modes. You are recommended to select 11a/n/ac mode, allowing 802.11a, 802.11n and 802.11ac wireless stations to access the AP.
<b>Bandwidth</b>	Specify the bandwidth of the wireless network. According to IEEE 802.11n standard, using higher bandwidth can increase wireless throughput. However, users may choose lower bandwidth due to the following reasons: <ul style="list-style-type: none"> <li>1. Increase the available number of channels within the limited total bandwidth.</li> <li>2. To avoid interference from overlapping channels occupied by other devices in the environment.</li> <li>3. Lower bandwidth can concentrate higher transmit power, increasing stability of wireless links over long distances.</li> </ul>
<b>Channel</b>	Specify a channel for the wireless network. If auto is selected, the AP will automatically choose a suitable channel.

Transmit Power	Specify a transmit power for the wireless network. A larger transmission power than needed may cause interference to other wireless networks.
Maximum Users	Specify the maximum number of clients that can be connected to the AP.
Antenna	Specify the antenna type. Only internal antenna is supported at present.
Fragment Threshold	Specify the fragment threshold for transmitting packets. If the size of the packet is larger than the fragment threshold, the packet will be fragmented into several packets. A value that is too low for the fragment threshold may result in poor wireless performance caused by the excessive packets. The recommended and default value is 2346 bytes.
Beacon Interval	Enter a value between 40 and 1000 in milliseconds to determine the duration between beacon packets that are broadcasted by the AP to synchronize the wireless network. The default is 100 milliseconds.
Airtime Fairness	Specify whether to enable Airtime Fairness feature. With this feature enabled, each client connected to the AP can get the same amount of time to transmit data, preventing low-data-rate clients from occupying too much network bandwidth and improving the network throughput. We recommend that you enable this function under multirate wireless networks.
RTS Threshold	Enter a value between 1 and 2347 to determine the packet size of data transmission through the AP. By default, the RTS (Request to Send) Threshold size is 2346. If the packet size is greater than the preset threshold, the AP sends Request of Send frames to a particular receiving station and negotiates the sending of a data frame, or else the packet will be sent immediately.
DTIM Period	This value indicates the number of beacon intervals between successive Delivery Traffic Indication Messages (DTIM) and this number is included in each Beacon frame. A DTIM is contained in Beacon frames to indicate whether the AP has buffered broadcast and/or multicast data for the client devices. Following a Beacon frame containing a DTIM, the access point will release the buffered broadcast and/or multicast data, if any exists. You can specify a value between 1-255 Beacon Intervals. The default value is 1, indicating the DTIM Interval is the same as the Beacon Interval. An excessive DTIM interval may reduce the performance of multicast applications. It is recommended to keep it as the default.
WMM	Specify whether to enable the WMM. With WMM enabled, this device uses the QoS function to guarantee the transmission of audio and video packets with high priority.
Broadcast Probe Response	Specify whether to enable the broadcast probe response function. The clients send broadcast probes to detect the wireless networks nearby. If the function is enabled, the AP will respond to the broadcast probe to let the clients know of its existence. With the function disabled, the client cannot find the AP by sending broadcast probes.
Short GI	Specify whether to enable the Short GI. Short GI is used to increase the throughput by reducing the guard interval time. It is recommended to enable this function.
Weak Signal Forbidden	Specify whether to enable the weak signal forbidden function. With this function enabled, the AP will forbid the client with a signal strength lower than a certain value from connecting.

**Weak Signal Discard**

Specify whether to enable the weak signal discard function. With this function enabled, the AP will discard the client with a signal strength lower than a certain value.

Click **OK** to complete the configuration. Click **Default Settings** to restore the parameters to the default.

## 5.2 Rate Settings

Choose the menu **Radio > Rate Settings > Rate Settings** to load the following page. Specify the data transmission rate on this page.

Figure 5-3 Rate Settings

The screenshot shows a web interface for configuring rate settings. At the top, there is a tab labeled "Rate Settings". Below it, there are five sections for different IEEE 802.11 standards: 802.11a, 802.11b, 802.11g, 802.11n, and 802.11ac. Each section has three rows of settings: "Basic Rate", "Supported Rate", and "Multicast Rate".

- 802.11a:** Basic Rate:  6  9  12  18  24  36  48  54; Supported Rate:  6  9  12  18  24  36  48  54; Multicast Rate:  6  9  12  18  24  36  48  54  Auto.
- 802.11b:** Basic Rate:  1  2  5.5  11; Supported Rate:  1  2  5.5  11; Multicast Rate:  1  2  5.5  11  Auto.
- 802.11g:** Basic Rate:  1  2  5.5  6  9  11  12  18  24  36  48  54; Supported Rate:  1  2  5.5  6  9  11  12  18  24  36  48  54; Multicast Rate:  1  2  5.5  6  9  11  12  18  24  36  48  54  Auto.
- 802.11n:** Basic MCS Index: ---; Supported MCS Index: 23.
- 802.11ac:** Basic MCS Set: ---; Supported MCS Set: NSS\_3\_MCS\_0-9.

At the bottom of the page, there are two buttons: "Save" and "Default Setting".

**Note:**

1. If the connected APs have enabled the radio, the configured rate parameters will take effect only after the APs reboot or their radios are turned off then turned on again.
2. If the value of 11n's MCS index is greater than the maximum value supported by the AP, the maximum value is the effective value of AP's MCS index.

802.11a	<p><b>Basic Rate:</b> Specify the basic rate set with which the 802.11a clients are allowed to access the network. At least one rate should be selected from the rate set. 6Mbps, 12Mbps and 24Mbps are selected by default.</p> <p><b>Supported Rate:</b> Specify the supported rate for 802.11a clients. The supported rate set should not overlap with the basic rate set. 9Mbps 18Mbps, 36Mbps 48Mbps and 54Mbps are selected by default.</p> <p><b>Multicast Rate:</b> Specify the multicast rate for the 802.11a multicast packets. The rate should be selected from the basic rate set. When auto is selected, the system will select a suitable rate from the basic rate set automatically.</p>
802.11b	<p><b>Basic Rate:</b> Specify the basic rate with which 802.11b clients are allowed to access the wireless network. At least one rate should be selected in the rate set. 1Mbps and 2Mbps are selected by default.</p> <p><b>Supported Rate:</b> Specify the supported rate for 802.11b clients. The supported rate should not overlap with the basic rate that has been set. 5.5Mbps and 11Mbps are selected by default.</p> <p><b>Multicast Rate:</b> Specify the multicast rate for the 802.11b multicast packets. The rate should be selected from the basic rate set. When auto is selected, the system will select a suitable rate from the basic rate set automatically.</p>
802.11g	<p><b>Basic Rate:</b> Specify the basic rate with which the 802.11g clients are allowed to access the network. At least one rate should be selected in the rate set. 1Mbps, 2Mbps, 5.5 Mbps and 11Mbps are selected by default.</p> <p><b>Supported Rate:</b> Specify the supported rate for 802.11g clients. The supported rate set should not overlap with the basic rate set. 6Mbps, 9Mbps, 12Mbps, 18Mbps, 24Mbps, 36Mbps, 48Mbps and 54Mbps are selected by default.</p> <p><b>Multicast Rate:</b> Specify the multicast rate for the 802.11g multicast packets. The rate should be selected from the basic rate set. When auto is selected, the system will select a suitable rate from the basic rate set automatically.</p>
802.11n	<p><b>Basic MCS Index:</b> Specify the basic MCS index for 802.11n client. The maximum MCS index value for 802.11n clients should be equal to or greater than the basic MCS index value. Otherwise, the clients cannot be allowed to access the wireless network. The default setting is blank. If a value is selected, only 802.11n clients are allowed to access the network.</p> <p><b>Supported MCS Index:</b> Specify the support MCS index for the device. The support MCS index should be equal to or greater than the basic MCS index.</p>
802.11ac	<p><b>Basic MCS Set:</b> Specify the basic MCS set for the device. The 802.11ac clients should support the number of antennas and MCS index range regulated by the basic MCS set. Otherwise, the clients cannot access the wireless network.</p> <p><b>Supported MCS Set:</b> Specify the support MCS set for the device. The corresponding number of antennas and MCS index range of the support MCS set should be equal to or greater than that of basic MCS set.</p>

**Note:**

For the connected APs enabled with radio, the rate settings won't take effect until the APs reboot or their radios are disabled and enabled again.

## 5.3 Band Steering

There are clients that only support the 2.4GHz band and clients that support dual band in a wireless network. If all the clients connect to the 2.4GHz band, the 2.4GHz band will become very congested, reducing the network performance. With band steering enabled, the AP would steer the dual band clients to connect to the 5GHz first, which would balance the band connections and improve the network performance. When enabling band steering, please ensure the SSIDs of both 2.4GHz and 5GHz bands are the same.

The following example is used to illustrate the process of band steering.

Figure 5-4 Band Steering Process

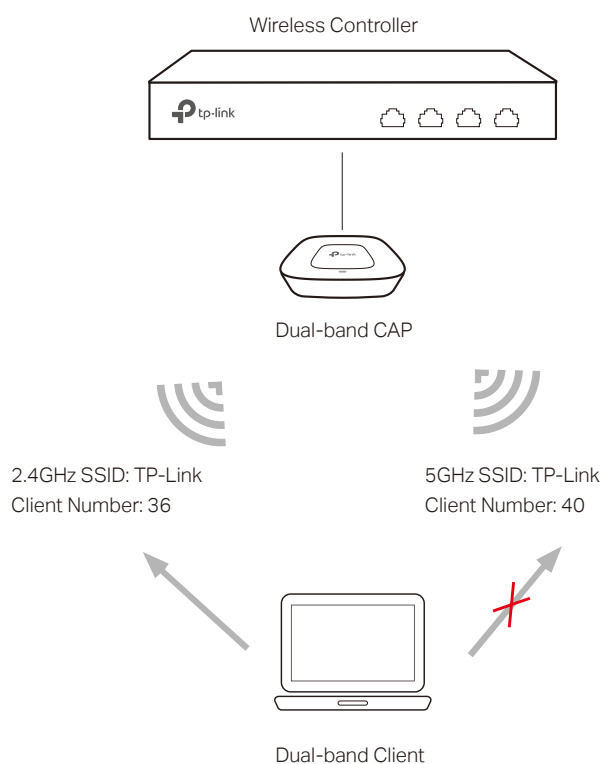

The 2.4GHz SSID and 5GHz SSID of the dual-band CAP are set the same. If a 2.4GHz client or 5GHz client requests to connect to the CAP, the band steering won't take effect and the client will connect to the 2.4GHz or 5GHz directly. If a dual band client requests to connect to the CAP, due to band steering, the CAP will lead the client to connect to the 5GHz band first.

When the wireless network satisfies the following two conditions:

- 1 The client number of the 5GHz band reaches or exceeds the maximum client numbers that are allowed to connect (40 as an example).
- 2 The difference value in client number of the 2.4GHz band and the 5GHz band reaches or exceeds the difference threshold set in band steering setting (4 as an example,  $40 - 36 \geq 4$ ).

Due to band steering, a new dual band client will be rejected from connecting to the 5GHz band and be allowed to connect to the 2.4GHz band.



But if the client repeatedly requests to connect to the 5GHz, and the rejection exceeds the maximum failure number set in band steering setting, the client will be allowed to connect.

Choose the menu **Radio > Band Steering > Band Steering** to load the following page. Check the Enable radio button to enable the band steering function.

Figure 5-5 Band Steering

Setting	Value	Range
5GHz Maximum Connection Threshold	40	(2-40)
Difference Threshold	4	(1-8)
Maximum Failure Number	10	(0-100)

<b>5GHz Maximum Connection Threshold</b>	Specify the maximum number of clients that are allowed to connect to the 5GHz band. When the client number meets the 5GHz maximum connection threshold and difference threshold, the AP will prevent more APs from connecting to the 5GHz band.
<b>Difference Threshold</b>	Specify the maximum difference value between the number of clients connected to the 5GHz band and the number connected to the 2.4GHz band. When the client connections meet the 5GHz maximum connection threshold and the difference threshold, the AP will prevent more APs from connecting to the 5GHz band.
<b>Maximum Failure Number</b>	Specify the maximum number of failed connection attempts of the client. If the clients continuously request to connect to the 5GHz band and the number of failed attempts exceeds the specified number, the CAP will accept the connection request.

Click **Save** to finish the settings.

## 5.4 Wi-Fi Roaming

Wi-Fi roaming is a technology that keeps a station connected to the network while the station is moving from one Access Point to another.

For example, a client can walk through a facility while carrying on a conversation over a Wi-Fi phone. The Wi-Fi radio inside the phone automatically roams from one access point to another as needed to provide seamless connectivity.

Choose the menu **Radio > Wi-Fi Roaming** to load the following page. Configure the two 802.11k options.

Figure 5-6 Wi-Fi Roaming

11k

Neighbor List:  Enable  Disable

Neighbor List Dual Band:  Enable  Disable

Save

---

**Neighbor List**

Choose to whether enable Wi-Fi roaming feature. With this option enabled, Wi-Fi roaming will take effect on the 2.4GHz band.

---

**Neighbor List Dual Band**

Choose to whether enable Wi-Fi roaming on both of the 2.4GHz and 5GHz bands.

---

**Note:**

Only when Neighbor List is enabled, will Neighbor List Dual Band take effect.

Click **Save** to finish the settings.

# 6 Wireless

## 6.1 Wireless Service

Choose the menu **Radio > Wireless > Wireless Service** to load the following page.

Figure 6-1 Wireless Service

<input type="checkbox"/>	ID	SSID	Description	Security	Status	Radio Binding	Operation
<input type="checkbox"/>	1	RD department	for all	WPA-PSK/WPA2-PSK	Enabled		
<input type="checkbox"/>	2	Market	For Dual Band	WPA-PSK/WPA2-PSK	Enabled		

Total 2 Items, 10 Per Page | Current 1/1 Page 1~2 Items

Specify and view the wireless service on this page. Click **Add** to create a new wireless service. Click button, you can go into the radio binding page.

Figure 6-2 Add a New Wireless Service

<input type="checkbox"/>	ID	SSID	Description	Security	Status	Radio Binding	Operation
--	--	---	---	---	---	---	---

Status:  Enable  Disable

SSID:  (1-32 characters)

Description:  (1-32 characters, optional)

AP Isolation:  Enable  Disable

SSID Broadcast:  Enable  Disable

Security:  ▼

<b>Status</b>	Specify whether to enable the wireless network.
<b>SSID</b>	Specify the SSID (Service Set Identifier) for the wireless network. The SSID should be unique.
<b>Description</b>	Specify a description for the entry to make it easier to search for and manage.

<b>AP Isolation</b>	Enable AP isolation to isolate the wireless clients connected to the same AP so that they cannot communicate with each other. This setting cannot take effect in other APs; that is, AP isolation cannot isolate the clients connected to different APs with the same SSIDs.
<b>SSID Broadcast</b>	With this option enabled, the AP will broadcast the SSID to the nearby hosts, so that those hosts can find the wireless network identified by this SSID. With this option disabled, users must enter the SSID manually to connect to the AP.
<b>Security</b>	Specify the security option of the wireless network. If all the clients are allowed to access the wireless network, please select <b>None</b> . For the safety of the wireless network, you are suggested to encrypt your wireless network with password. This device provides three security options: WPA/WPA2 (Wi-Fi Protected Access) and WPA-PSK/WPA2-PSK (WPA Pre-Shared Key). WPA-PSK/WPA2-PSK is recommended. Settings vary in different security options as the details is in the following introduction.

Following is the detailed introduction of security mode: **WPA/WPA2** and **WPA-PSK/WPA2-PSK**.

- **WPA-PSK/WPA2-PSK**

Based on pre-shared key. It is characterized by higher safety and simple settings, which suits for common households and small business. WPA-PSK has two versions: WPA-PSK and WPA2-PSK.

Figure 6-3 Security of WPA-PSK/WPA2-PSK

Security:	WPA-PSK/WPA2-PSK	▼	
Authentication Type:	Auto	▼	
Encryption:	Auto	▼	
Group Key Update Period:	86400		(30-604800 second. 0 means no update)
PSK Password:			(8-64 characters)

<b>Authentication Type</b>	Select one of the following versions: <b>Auto:</b> Select WPA or WPA2 automatically based on the wireless client's capability and request. <b>WPA-PSK:</b> Pre-shared key of WPA. <b>WPA2-PSK:</b> Pre-shared key of WPA2.
<b>Encryption</b>	Select the encryption type, including Auto, TKIP, and AES. The default setting is Auto, which can select TKIP (Temporal Key Integrity Protocol) or AES (Advanced Encryption Standard) automatically based on the wireless station's capability and request. AES is more secure than TKIP and TKIP is not supported in 802.11n mode. It is recommended to select AES as the encryption type.
<b>Group Key Update Period</b>	Enter the number of seconds (minimum 30) to control the time interval for the encryption key automatic renewal.
<b>PSK Password</b>	Configure the PSK password with ASCII or Hexadecimal characters. For ASCII, the length should be between 8 and 63 characters with a combination of numbers, letters (case-sensitive) and common punctuations. For Hexadecimal, the length should be 64 characters (case-insensitive, 0-9, a-f, A-F).

## ■ WPA/WPA2

Based on Radius Server, WPA can assign different passwords for different users and it is much safer than WPA-PSK. However, it has high maintenance costs and is only suitable for enterprise users. At present, WPA has two versions: WPA and WPA2.

Figure 6-4 Security of WPA/WPA2

Security:	<input type="text" value="WPA/WPA2"/>	
Authentication Type:	<input type="text" value="Auto"/>	
Encryption:	<input type="text" value="Auto"/>	
Group Key Update Period:	<input type="text" value="86400"/>	(30-604800 second. 0 means no update)
Radius Server IP:	<input type="text"/>	
Radius Port:	<input type="text"/>	(1024-65535)
Radius Password:	<input type="text"/>	(1-64 characters)

### Authentication Type

Select one of the following versions:

**Auto:** Select WPA-PSK or WPA2-PSK automatically based on the wireless station's capability and request.

**WPA:** Wi-Fi Protected Access.

**WPA2:** Version 2 of WPA.

### Encryption

Select the encryption type, including Auto, TKIP, and AES. The default setting is Auto, which can select TKIP (Temporal Key Integrity Protocol) or AES (Advanced Encryption Standard) automatically based on the wireless station's capability and request. AES is more secure than TKIP and TKIP is not supported in 802.11n mode. It is recommended to select AES as the encryption type.

### Group Key Update Period

Enter the number of seconds (minimum 30) to control the time interval for the encryption key automatic renewal.

### Radius Server IP

Enter the IP address of the Radius server.

### Radius Port

Enter the port number of the Radius server.

### Radius Password

Enter the share key of the Radius server.

Click  button, you can go into the radio binding page.

Figure 6-5 Radio Banding

Wireless Service

Wireless ?

SSID:

Select the Group:

VLAN Binding:  (1-4094, optional)

[Back to Wireless](#)
[Bound](#)
[Unbind](#)
[Search](#)
[Global Search](#)

<input type="checkbox"/>	ID	AP Name	Radio Frequency	Radio Mode	Binding Status	VLAN Binding
<input type="checkbox"/>	1	CAP1750-0000	1(2.4GHz)	802.11b/g/n	Bound	---
<input type="checkbox"/>	2	CAP1750-0000	2(5.0GHz)	802.11a/n/ac	Bound	---
<input type="checkbox"/>	3	CAP300-0001	1(2.4GHz)	802.11b/g/n	Bound	---

Total 3 Items,  Per Page | Current 1/1 Page 1~3 Items | 1

<b>SSID</b>	Displays the current wireless network.
<b>Select the Group</b>	Select the group to be displayed in the list.
<b>VLAN Binding</b>	Enter a VLAN ID into the field and Click <a href="#">Bound</a> above the list. The wireless network will be bound to the corresponding VLAN.
<a href="#">Bound</a>	Select the desired entries and click this button to bind the service to corresponding radios. Unlocked APs cannot be bound. Please refer to <a href="#">4.1 AP Settings</a> and check the box <b>Lock to AC Automatically</b> .
<a href="#">Unbind</a>	Select the desired entries and click this button to unbind the service in corresponding radios.
<a href="#">Back to Wireless</a>	Click this button to return to the wireless service page.

# 7 Authentication

## 7.1 MAC Authentication

MAC Authentication is based on VLAN and MAC address. The administrator can preset MAC Authentication entries to allow or deny the clients with specific MAC addresses and in specific VLANs to access the network. The clients do not need to install any client software, nor do any operation during the MAC authentication process.

With this feature configured, when a client tries to access the network, the AP sends the MAC address and VLAN information of the client to the AC. Based on the preset MAC Authentication entries, the AC checks whether the client is allowed to access the network or not. Only the clients allowed to access the network can go for the further portal authentication process.

As the following diagram shows, we configure Client 1 and Client 2 to the whitelist, and Client 3 to the blacklist on the AC. When these clients are trying to access the network, the AC will check the MAC authentication entries. According to these entries, Client 1 and Client 2 will be allowed to access the network, and Client 3 will be denied to access the network.

Figure 7-1 Topology for MAC Authentication

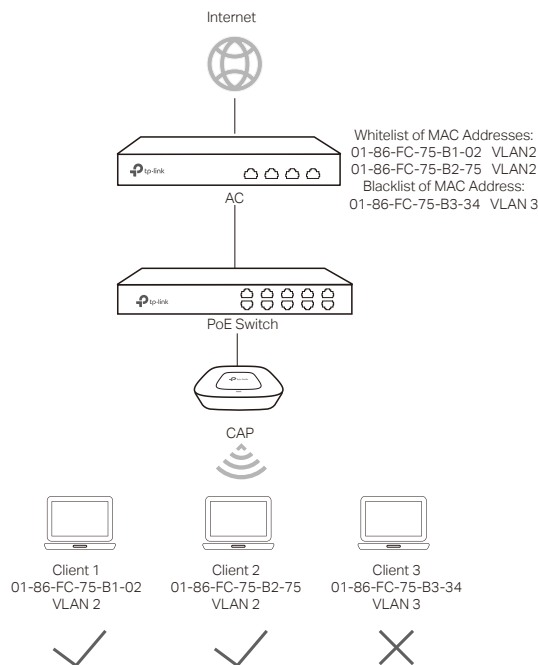

To configure MAC Authentication, refer to the following steps:

- 1 Choose the menu **Authentication > MAC Authentication > MAC Address** to bind the MAC addresses and VLANs of the clients to be authenticated.
- 2 Choose the menu **Authentication > MAC Authentication > MAC Authentication** to set MAC authentication rule on the VLANs.

## 7.1.1 MAC Address

Choose the menu **Authentication > MAC Authentication > MAC Address** to load the following page.

Figure 7-2 MAC Address

Backup MAC Address

Backup

Restore MAC Address

File:  Browse

Restore

Opening csv files in Excel may change a values' format and display. If you edit csv files using Excel, please format the cells into text format first.

MAC Address List

+ Add - Delete Search Global Search

<input type="checkbox"/>	ID	Name	MAC Address	VLAN Range	Operation
--	--	--	--	--	--

Total 0 Items , 10 Per Page | Current 0/0 Page 0~0 Items |

You can click **Backup** to back up all the MAC authentication entries in the CSV file which are in ANSI coding format. This file can be restored to the AC and all MAC addresses can be added into the MAC address list.

To add multiple MAC address entries at a time:

- 1 Save the MAC address entries as a CSV file with ANSI coding format in the AC. You can use the **Backup MAC Address** function to obtain a CSV file to view the correct format.
- 2 Click **Browse** to select the file path, and then click **Restore** to restore the file.

### Note:

Using Excel to open the CSV file may cause some numerical format changes, and the number may be displayed incorrectly. If you use Excel to edit the CSV file, please set the cell format as text.

In the MAC address list you can view the MAC address entries.

Click **+ Add** to add a new MAC address entry, as shown in the following figure.



Figure 7-3 Add a new MAC Address Entry

--	--	--	--	--	--
Name:	<input type="text"/>	(1-50 characters)			
MAC Address:	<input type="text"/>	(XX-XX-XX-XX-XX-XX)			
VLAN Range:	<input type="text"/>	(1-4094, optional)			
<input type="button" value="OK"/>		<input type="button" value="Cancel"/>			

<b>Name</b>	Specify the name for the entry.
<b>MAC Address</b>	Specify the MAC address of the client.
<b>VLAN Range</b>	Specify the VLAN range. The range is 1 to 4094. Number and range are both supported. The ranges can be separated by commas. For example: 1 11-20 1,3,5,4090-4094

## 7.1.2 MAC Authentication

Choose the menu **Authentication > MAC Authentication > MAC Authentication** to load the following page.

Figure 7-4 MAC Authentication

MAC Authentication List							
<input checked="" type="checkbox"/> Enable <input checked="" type="checkbox"/> Disable <input checked="" type="checkbox"/> Add <input checked="" type="checkbox"/> Delete <input checked="" type="checkbox"/> Search <input checked="" type="checkbox"/> Global Search							
<input type="checkbox"/>	ID	MAC Authentication Name	Effective VLAN Range	Description	Authentication Mode	Status	Operation
--	--	--	--	--	--	--	--

Here you can view the MAC Authentication List.

Click  **Add** to add a new entry.

Figure 7-5 Add a MAC Authentication List

MAC Authentication Name:	<input type="text"/>	(1-50 characters)
Effective VLAN Range:	<input type="text"/>	(1-4094, optional)
Description:	<input type="text"/>	(1-50 characters, optional)
Authentication Mode:	<input checked="" type="radio"/> White List <input type="radio"/> Black List	
Status:	<input type="radio"/> Enable <input checked="" type="radio"/> Disable	
<input type="button" value="OK"/>		<input type="button" value="Cancel"/>

MAC Authentication Name	Specify or check the name of the MAC authentication entry to make it easier to search for and manage.
Effective VLAN Range	Specify or check the effective VLAN range of the MAC authentication entry. The range is 1 to 4094. Number and range are both supported. The ranges can be separated by commas. For example: 1 11-20 1,3,5,4090-4094
Description	Specify or check the description of the authentication entry to make it easier to search for and manage.
Authentication Mode	Black List: All the MAC addresses in this authentication mode are forbidden to access the network.
Status	Specify whether to enable this authentication entry.

## 7.2 Portal Authentication

AC provides several types of portal authentication, including **Web Authentication, Onekey Online, Voucher, SMS, Facebook, Remote Portal**.

To provide portal authentication service, two kinds of servers are required: web server which is used to provide login page for the clients, and authentication server which is used to authenticate the clients. The web server and authentication server can be the built-in servers of the AC or the external connected servers. Which kinds of servers are used to provide portal service is determined by the portal authentication types and your choices.

Figure 7-6 Portal Topology

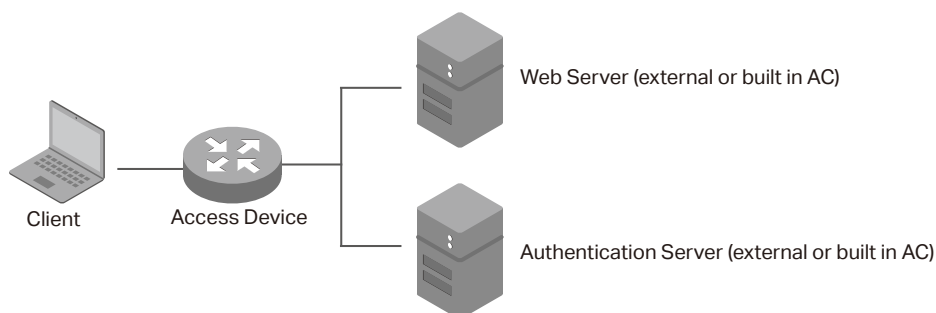

### ■ Web Server

For **Web Authentication, Onekey Online, Voucher** and **SMS**, the AC uses its built-in web server to provide login page for the clients. Before configuring such portal authentication features, you need to set the login page in the **Splash Page** module.

For **Facebook**, the web sever of Facebook is used to provide login page and Facebook Page for the clients.

For **Remote Portal**, you need to build a remote portal server on your network to provide customized login page for the clients.

### ■ Authentication Server

For **Web Authentication** and **Remote Portal**, there are two methods to authenticate the clients: using the built-in authentication server of the AC or using the remote authentication server on the network. You can configure the remote authentication server in the **Authentication Sever** module.

For **Onekey Online** and **Voucher**, the AC uses the built-in authentication server to authentication the clients.

For **SMS**, the AC uses the authentication server of service provider Twilio to authenticate the clients.

For **Facebook**, the AC uses the authentication server of Facebook to authenticate the clients.

**Note:**

Before configuring portal authentication, make sure that the IP address of the AC's interface that manages the AP and the IP addresses of the clients are routable.

## 7.2.1 Splash Page

Choose the menu **Authentication > Portal Authentication > Splash Page** to load the following page.

Figure 7-7 Splash Page

<input type="checkbox"/>	ID	Page Name	Authentication Type	Description	Operation
<input type="checkbox"/>	--	--	--	--	--

Total 0 Items | 10 Per Page | Current 0/0 Page 0~0 Items |

Here you can upload pictures or use the default template to set the splash pages for subsequent authentication to meet the requirements of advertisement promotions.

Click **Add** to add a new entry. There are four authentication types of the splash page, including Web Authentication, Onekey Online, Voucher and SMS.

Figure 7-8 Add a Splash Page

<b>Page Name</b>	Specify the name of the splash page template.
<b>Authenticaiton Type</b>	Select the authentication type of the splash page. Options include <b>Web Authentication, Onekey Online, Voucher</b> and <b>SMS</b> .  <b>Web Authentication:</b> Clients need to enter a username and password to log in, and can access the network after successful authentication.  <b>Onekey Online:</b> Clients can access the network without entering any parameters on the login page.  <b>Voucher:</b> Clients need to enter the voucher code to log in, and can access the network after successful authentication.  <b>SMS:</b> Clients need to enter the verification code received by their mobile phones to log in, and can access the network after successful authentication.
<b>Page Title</b>	Specify the page title for the authentication.
<b>Background</b>	Select the background type. Two types are supported: <b>Solid Color</b> selected on the page and <b>Picture</b> uploaded from your local computer.
<b>Background Color</b>	If <b>Solid Color</b> is selected, configure your desired background color through the color picker or by entering the RGB values manually.
<b>Background Picture</b>	If <b>Picture</b> is selected, click the <b>Upload</b> button and a window will pop up. Click the <b>Browse</b> button and select a background picture. You can drag and scale the clipping region to edit the picture.
<b>Logo</b>	Click the <b>Upload</b> button and a window will pop up. Click the <b>Browse</b> button and select a logo picture. You can drag and scale the clipping region to edit the picture.
<b>Logo Position</b>	Set the position of the logo picture. The options include Middle, Upper and Lower.

Welcome Information	Specify the welcome information.
Welcome Information Color	Select your desired text color for the welcome information through the color picker or by entering the RGB values manually.
Copyright	Specify the copyright information.
Copyright Information Color	Select your desired text color for Copyright information through the color picker or by entering the RGB values manually.
Description	Specify a description for the entry to make it easier to search for and manage.
Input Box Frame Color	Select your desired color for the input box border through the color picker or by entering the RGB values manually.
Button Position	Set the position of the login button. The options include Middle, Upper and Lower.
Button Color	Select your desired login button color through the color picker or by entering the RGB values manually.
Button Text Color	Select your desired text color for the button through the color picker or by entering the RGB values manually.

On the right side of the page, you can click the buttons **Tablet PC**, **Mobile Phone** and **PC** to preview the login pages on these kinds of devices.

## 7.2.2 Web Authentication

In Web Authentication, clients can use the user accounts to pass the authentication.

Choose the menu **Authentication > Portal Authentication > Web Authentication** to load the following page.

Figure 7-9 Web Authentication

Web Authentication									
<input type="checkbox"/>	ID	Splash Page	SSID	Server Type	Non-sense Authentication	Advertisement	Description	Status	Operation
	--	--	--	--	--	--	--	--	--

Enable  
  Disable  
  Add  
  Delete  
  Search

Here you can view the Web Authentication information and edit the entries.

Click **+ Add** to add a new entry. There are two authentication server types, including Local Authentication Server and Remote Authentication Server.

- Local Authentication Server

Select Local Authentication Server as the Authentication Server Type, and the following the page will appear.

Figure 7-10 Local Authentication Server Page

--	--	--	--	--	--	--	--	--	--
<p>Status: <input type="radio"/> On <input checked="" type="radio"/> Off</p> <p>SSID: <input type="text" value="---"/></p> <p>Splash Page: <input type="text" value="---"/></p> <p>Authenticaiton Server Type: Local Authentication Server</p> <p>Success Redirect URL: <input type="text"/></p> <p>(Optional. Enter 1-120 letters, digits or special characters)</p> <p>Fail redirect URL: <input type="text"/></p> <p>(Optional. Enter 1-120 letters, digits or special characters)</p> <p>Non-sense Authentication: <input type="radio"/> Enable <input checked="" type="radio"/> Disable</p> <p>Advertisement: <input type="radio"/> Enable <input checked="" type="radio"/> Disable</p> <p>Description: <input type="text"/> (1-50 characters, optional)</p> <p><b>Note:</b>          1. If you have configured the failure redirect URL, the URL will join the free authentication policy automatically and no manual configuration is needed.          2. If the remote authentication server is selected, and the server is configured with an online time duration for the users, then this time duration is the time that users can connect to the wireless network for free.</p> <p>OK Cancel</p>									

Status	Specify the status of the entry.
SSID	Specify the SSIDs of the Web authentication. Note: The SSIDs abeled "Bound" are being used by other authentication entries. If these SSIDs are selected, the original configuration will be replaced by the current configuration.
Splash Page	Select the splash page of the Web authentication.
Authenticaiton Server Type	Specify the server type of the Web authentication. Here we select <b>Local Authentication Server</b> .
Success Redirect URL	Specify the redirect URL address after successful authentication.
Fail redirect URL	Specify the redirect URL address after the authentication failure.
Non-sense Authentication	With this option enabled, the non-sense authenticated users will pass the authentication automatically when connecting to the wireless network.
Advertisement	Specify whether to enable the Advertisement feature. With this feature enabled, you can add advertisement pictures on the authentication page. These advertisement pictures will be displayed before the login page appears. You can also allow users to skip the advertisement by enabling <b>Allow to Skip Advertisement</b> .

<b>Description</b>	Specify a description for the Web authentication entry to make it easier to search for and manage.
--------------------	--

**Note:**

When Local Authentication Server is selected, you need to add the login information of the allowed users. For detailed configuration, refer to [7.3 Local User Management](#).

■ Remote Authentication Sever

Select Remote Authentication Server as the Authentication Server Type, and the following the page will appear.

Figure 7-11 Remote Authentication Server Page

The screenshot shows a configuration window for a Remote Authentication Server. The fields are as follows:

- Status:** Radio buttons for On and Off. Off is selected.
- SSID:** A dropdown menu showing '---'.
- Splash Page:** A dropdown menu showing '---'.
- Authenticaiton Server Type:** A dropdown menu showing 'Remote Authentication Server'.
- Authentication Server Group:** A dropdown menu showing '---'.
- Free Authentication Timeout:** A text input field containing '30' and a label 'minutes (1-1440)'.
- Success Redirect URL:** A large text area with a note below it: '(Optional. Enter 1-120 letters, digits or special characters)'.
- Fail redirect URL:** A large text area with a note below it: '(Optional. Enter 1-120 letters, digits or special characters)'.
- Non-sense Authentication:** Radio buttons for Enable and Disable. Disable is selected.
- Advertisement:** Radio buttons for Enable and Disable. Disable is selected.
- Description:** A text input field with a label '(1-50 characters, optional)'.

**Note:**

1. If you have configured the failure redirect URL, the URL will join the free authentication policy automatically and no manual configuration is needed.
2. If the remote authentication server is selected, and the server is configured with an online time duration for the users, then this time duration is the time that users can connect to the wireless network for free.

At the bottom of the window are 'OK' and 'Cancel' buttons.

<b>Status</b>	Specify the status of the entry.
<b>SSID</b>	Specify the SSIDs that will be enabled with Web authentication. Note: The SSIDs labeled "Bound" are being used by other authentication entries. If these SSIDs are selected, the original configuration will be replaced by the current configuration.
<b>Splash Page</b>	Select the splash page of the Web authentication.

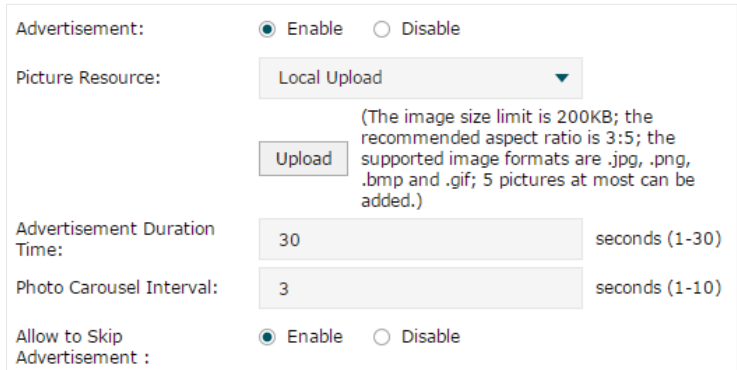
Authenticaiton Server Type	Specify the server type of the Web authentication. Here we select Remote Authentication Server. To configure Radius server, refer to <a href="#">Authentication Server</a> .
Authentication Server Group	Select the server group of the Web authentication.
Free Authentication Timeout	Set the free online duration for the users. Note: If the remote authentication server is configured with an online time duration for the users, then the time duration set on the server will take effect instead of Free Authentication Timeout set here.
Success Redirect URL	Specify the redirect URL address after successful authentication.
Fail redirect URL	Specify the redirect URL address after the authentication failed.
Non-sense Authentication	If non-sense authentication is enabled, the non-sense authenticated users will pass the authentication automatically when connecting to the wireless network.
Advertisement	<p>Specify whether to enable the Advertisement feature. With this feature enabled, you can add advertisement pictures on the authentication page. These advertisement pictures will be displayed before the login page appears. The required parameters are as follows:</p> <p><b>Picture Resource:</b> You can add up to 5 advertisement pictures. When several pictures are added, they will be played in a loop. There are two picture resources: Local Upload and External Link.</p> <p><b>Advertisement Duriation Time:</b> Specify how long the advertisement will be displayed for. For this duration, the pictures will be played in a loop. Enter a value from 1 to 30 seconds. If the duration time is not enough for all the pictures, the rest will not be displayed.</p> <p><b>Photo Carousel Interval:</b> Specify the picture carousel interval. If this value is set as 5 seconds, the first picture will be displayed for 5 seconds, followed by the second picture for 5 seconds, and so on. Enter a value from 1 to 10 seconds.</p> <p><b>Allow to Skip Advertisement:</b> Specify whether to enable this feature. With this feature enabled, the user can click the Skip button to skip the advertisement.</p> 
Description	Specify a description for the Web authentication entry to make it easier to search for and manage.



## 7.2.3 Onekey Online

In Onekey Online Authentication, clients can pass the authentication without entering any parameters on the login page .

Choose the menu **Authentication > Portal Authentication > Onekey Online** to load the following page.

Figure 7-12 Onekey Online

Onekey Online							
<input checked="" type="checkbox"/> Enable <input checked="" type="checkbox"/> Disable <input checked="" type="checkbox"/> Add <input checked="" type="checkbox"/> Delete <input checked="" type="checkbox"/> Search							
<input type="checkbox"/>	ID	Splash Page	SSID	Advertisement	Description	Status	Operation
<input type="checkbox"/>	--	--	--	--	--	--	--

Here you can view the Onekey Online Authentication information and edit the entries.

Click **+ Add** to add a new entry.

Figure 7-13 Add a New Onekey Online Entry

ID	Operation
--	--

Status:  On  Off

SSID:

Splash Page:

Free Authentication Timeout:  minutes (1-1440)

Advertisement:  Enable  Disable

Description:  (1-50 characters, optional)

Configure the related parameters and click **OK**.

<b>Status</b>	Specify whether to turn on the Onekey Online authentication entry.
<b>SSID</b>	Specify the SSIDs that will be enabled with Onekey Online authentication. Note: The SSIDs labeled "Bound" are being used by other authentication entries. If these SSIDs are selected, the original configuration will be replaced by the current configuration.
<b>Splash Page</b>	Select the splash page of Onekey Online authentication.
<b>Free Authentication Timeout</b>	Select the free online time for users who have passed onekey online authentication.

## Advertisement

Specify whether to enable the Advertisement feature. With this feature enabled, you can add advertisement pictures on the authentication page. These advertisement pictures will be displayed before the login page appears. The required parameters are as follows:

**Picture Resource:** You can add up to 5 advertisement pictures. When several pictures are added, they will be played in a loop. There are two picture resources: Local Upload and External Link.

**Advertisement Duration Time:** Specify how long the advertisement will be displayed for. For this duration, the pictures will be played in a loop. Enter a value from 1 to 30 seconds. If the duration time is not enough for all the pictures, the rest will not be displayed.

**Photo Carousel Interval:** Specify the picture carousel interval. If this value is set as 5 seconds, the first picture will be displayed for 5 seconds, followed by the second picture for 5 seconds, and so on. Enter a value from 1 to 10 seconds.

**Allow to Skip Advertisement:** Specify whether to enable this feature. With this feature enabled, the user can click the Skip button to skip the advertisement.

The screenshot shows a configuration form for the Advertisement feature. It includes the following fields and options:

- Advertisement:** Radio buttons for  Enable and  Disable.
- Picture Resource:** A dropdown menu set to "Local Upload" with an "Upload" button. A note below states: "(The image size limit is 200KB; the recommended aspect ratio is 3:5; the supported image formats are .jpg, .png, .bmp and .gif; 5 pictures at most can be added.)"
- Advertisement Duration Time:** A text input field containing "30" with the label "seconds (1-30)".
- Photo Carousel Interval:** A text input field containing "3" with the label "seconds (1-10)".
- Allow to Skip Advertisement:** Radio buttons for  Enable and  Disable.

## Description

Specify a description for the onekey online authentication entry to make it easier to search for and manage.

## 7.2.4 Voucher

In Voucher Authentication, you can distribute the voucher codes that are automatically generated by the AC to the clients. Clients can enter the voucher codes on the login page to access the network.

### Note:

To create voucher codes, refer to [Voucher Management](#).

Choose the menu **Authentication > Portal Authentication > Voucher** to load the following page.

Figure 7-14 Voucher

The screenshot shows the Voucher management interface. At the top, there is a header "Voucher" and a toolbar with icons for Enable (checked), Disable, Add, Delete, and Search. Below the toolbar is a table with the following columns: ID, Splash Page, SSID, Non-sense Authentication, Advertisement, Description, Status, and Operation. The table contains one row with "--" in all cells.

	ID	Splash Page	SSID	Non-sense Authentication	Advertisement	Description	Status	Operation
<input type="checkbox"/>	--	--	--	--	--	--	--	--

Here you can view the Voucher Authentication information and edit the entries.

Click  **Add** to add a new entry.

Figure 7-15 Add a New Voucher Entry

--	--	--	--	--	--	--	--	--
----	----	----	----	----	----	----	----	----

Status:  On  Off

SSID:

Splash Page:

Success Redirect URL:

(Optional. Enter 1-120 letters, digits or special characters)

Fail redirect URL:

(Optional. Enter 1-120 letters, digits or special characters)

Non-sense Authentication:  Enable  Disable

Advertisement:  Enable  Disable

Description:  (1-50 characters, optional)

**Note:**  
1. If you have configured the failure redirect URL, the URL will join the free authentication policy automatically and no manual configuration is needed.

Configure the related parameters and click **OK**.

<b>Status</b>	Specify whether to turn on the Voucher authentication entry.
<b>SSID</b>	Specify the SSIDs that will be enabled with Voucher authentication. Note: The SSIDs labeled "Bound" are being used by other authentication entries. If these SSIDs are selected, the original configuration will be replaced by the current configuration.
<b>Splash Page</b>	Select the splash page of Onekey Online authentication.
<b>Success Redirect URL</b>	Specify the redirect URL address after successful authentication
<b>Fail redirect URL</b>	Specify the redirect URL address after the authentication failure.
<b>Non-sense Authentication</b>	If non-sense authentication is enabled, the non-sense authenticated users will pass the authentication automatically when connecting to the wireless network.

## Advertisement

Specify whether to enable the Advertisement feature. With this feature enabled, you can add advertisement pictures on the authentication page. These advertisement pictures will be displayed before the login page appears. The required parameters are as follows:

**Picture Resource:** You can add up to 5 advertisement pictures. When several pictures are added, they will be played in a loop. There are two picture resources: Local Upload and External Link.

**Advertisement Duration Time:** Specify how long the advertisement will be displayed for. For this duration, the pictures will be played in a loop. Enter a value from 1 to 30 seconds. If the duration time is not enough for all the pictures, the rest will not be displayed.

**Photo Carousel Interval:** Specify the picture carousel interval. If this value is set as 5 seconds, the first picture will be displayed for 5 seconds, followed by the second picture for 5 seconds, and so on. Enter a value from 1 to 10 seconds.

**Allow to Skip Advertisement:** Specify whether to enable this feature. With this feature enabled, the user can click the Skip button to skip the advertisement.

The screenshot shows a configuration form for advertisements. It includes the following fields and options:

- Advertisement:** Radio buttons for  Enable and  Disable.
- Picture Resource:** A dropdown menu currently set to "Local Upload". Below it is an "Upload" button and a note: "(The image size limit is 200KB; the recommended aspect ratio is 3:5; the supported image formats are .jpg, .png, .bmp and .gif; 5 pictures at most can be added.)"
- Advertisement Duration Time:** A text input field containing "30" with the label "seconds (1-30)".
- Photo Carousel Interval:** A text input field containing "3" with the label "seconds (1-10)".
- Allow to Skip Advertisement:** Radio buttons for  Enable and  Disable.

## Description

Specify a description for the Voucher entry to make it easier to search for and manage.

## 7.2.5 SMS

In SMS Authentication, the client can get a verification code using a mobile phone and enter the code to pass the authentication.

Choose the menu **Authentication > Portal Authentication > SMS** to load the following page.

Figure 7-16 SMS Page

The screenshot shows the SMS configuration page. At the top, there is a header "SMS" and a toolbar with icons for  Enable,  Disable,  Add,  Delete, and  Search. Below the toolbar is a table with the following columns: ID, Splash Page, SSID, Advertisement, Description, Status, and Operation. The table contains one row with dashes "--" in each cell.

ID	Splash Page	SSID	Advertisement	Description	Status	Operation
--	--	--	--	--	--	--

Here you can view the SMS Authentication information and edit the entries.

Click  Add to add a new entry.

Figure 7-17 Add a New SMS Entry

<input type="checkbox"/>	ID	Splash Page	SSID	Advertisement	Description	Status	Operation
--	--	--	--	--	--	--	--

Status:  On  Off

SSID:

Splash Page:

We provide Twilio API service. Please configure your account information:

Twilio SID:

Authentication Token:

Phone Number:  (e.g., +16175551212)

Free Authentication Timeout:  minutes (1-1440)

Advertisement:  Enable  Disable

Description:  (1-50 characters, optional)

Configure the following parameters. Note that you need to first go to the Twilio website to register an account and get the following three parameters: Twilio SID, Authentication Token and Phone Number.

Status	Specify whether to turn on the SMS authentication entry.
SSID	Specify the SSIDs that will be enabled with SMS authentication. Note: The SSIDs labeled "Bound" are being used by other authentication entries. If these SSIDs are selected, the original configuration will be replaced by the current configuration.
Splash Page	Select the splash page of SMS authentication.
Twilio SID	Enter the Account SID for Twilio API Credentials.
Authentication Token	Enter the Authentication Token for Twilio API Credentials.
Phone Number	Enter the phone number that is used to send verification messages to the clients.
Free Authentication Timeout	Specify the permitted online time of the clients who have passed SMS authentication.

## Advertisement

Specify whether to enable the Advertisement feature. With this feature enabled, you can add advertisement pictures on the authentication page. These advertisement pictures will be displayed before the login page appears. The required parameters are as follows:

**Picture Resource:** You can add up to 5 advertisement pictures. When several pictures are added, they will be played in a loop. There are two picture resources: Local Upload and External Link.

**Advertisement Duration Time:** Specify how long the advertisement will be displayed for. For this duration, the pictures will be played in a loop. Enter a value from 1 to 30 seconds. If the duration time is not enough for all the pictures, the rest will not be displayed.

**Photo Carousel Interval:** Specify the picture carousel interval. If this value is set as 5 seconds, the first picture will be displayed for 5 seconds, followed by the second picture for 5 seconds, and so on. Enter a value from 1 to 10 seconds.

**Allow to Skip Advertisement:** Specify whether to enable this feature. With this feature enabled, the user can click the Skip button to skip the advertisement.

The screenshot shows a configuration form for advertisements. It includes the following fields and options:

- Advertisement:** Radio buttons for  Enable and  Disable.
- Picture Resource:** A dropdown menu set to "Local Upload" with an "Upload" button. A note below states: "(The image size limit is 200KB; the recommended aspect ratio is 3:5; the supported image formats are .jpg, .png, .bmp and .gif; 5 pictures at most can be added.)"
- Advertisement Duration Time:** A text input field containing "30" with the label "seconds (1-30)".
- Photo Carousel Interval:** A text input field containing "3" with the label "seconds (1-10)".
- Allow to Skip Advertisement:** Radio buttons for  Enable and  Disable.

## Description

Specify a description for the SMS entry to make it easier to search for and manage.

## 7.2.6 Facebook

In Facebook Authentication, the login page is your own Facebook Page that are bound to the AC, and you can customize your Facebook Page according to your actual needs. AC uses the Facebook server to authenticate the clients, and the logged-in clients will be redirected to your Facebook Page.

Choose the menu **Authentication > Portal Authentication > Facebook** to load the following page.

Figure 7-18 Facebook

The screenshot shows the Facebook configuration page. At the top, there is a header "Facebook" and a row of action buttons:  Enable,  Disable,  Add,  Delete, and  Search. Below this is a table with the following columns:  (checkbox), ID, SSID, Configuration, Facebook Page, Description, Status, and Operation. The table contains one row with dashes "--" in all cells.

<input type="checkbox"/>	ID	SSID	Configuration	Facebook Page	Description	Status	Operation
--	--	--	--	--	--	--	--

Here you can view the Facebook Authentication information and edit the entries.

Click  Add to add a new entry.

Figure 7-19 Add a New Facebook Entry

--	--	--	--	--	--	--	--
Status:	<input type="radio"/> On <input checked="" type="radio"/> Off						
SSID:	<input type="text" value="---"/>						
Configuration:	<input type="button" value="Configuration"/>						
Facebook Page:	<input type="text" value="None"/>						
Description:	<input type="text"/> (1-50 characters, optional)						
<input type="button" value="OK"/>		<input type="button" value="Cancel"/>					

<b>Status</b>	Specify whether to turn on the Facebook authentication entry.
<b>SSID</b>	Specify the SSIDs that will be enabled with Facebook authentication. Note: The SSIDs labeled "Bound" are being used by other authentication entries. If these SSIDs are selected, the original configuration will be replaced by the current configuration.
<b>Configuration</b>	Click this button to specify the Facebook Page. For details, refer to the following introduction.
<b>Facebook Page</b>	Displays the name of the specified Facebook Page.
<b>Description</b>	Specify a description for the Facebook entry to make it easier to search for and manage.

Click the **Configuration** button and log in to your Facebook account in the pop-up window. Then configure the Facebook Wi-Fi parameters and click **Save Settings**.

Figure 7-20 Facebook Configuration Page

## Facebook Wi-Fi Configuration

AC500 v1.0 20170502023400

---

### Facebook Page

To use Facebook Wi-Fi you need to be the admin of a local business Page that has a valid location associated with it.

Select a Page ▼

### Bypass Mode

Your customers always have the option to skip checking in. They can do this by clicking on a link that lets them skip check-in, or by entering a Wi-Fi code that you provide to them.

Skip check-in link [?]
   
 Require Wi-Fi code [?]

### Session Length

Select the length of time your customers will have Wi-Fi for after they check in.

Five hours ▼

### Terms of Service

Optional: Add your own Terms of Service [?]

[Visit Help Center](#)
Save Settings

Facebook Page	Select a Facebook Page that has been created in advance. Note that a valid location should be associated with the Facebook Page.
Bypass Mode	Select bypass mode. There are two options: <b>Skip check-in link:</b> Users can directly skip check-in and access the network without any code. <b>Require Wi-Fi code:</b> Users need to enter the Wi-Fi code you configured here to access the network.
Session Length	Select how long the users will have Wi-Fi after they check in.
Terms of Service	(Optional) Check the box and specify the terms of service.

## 7.2.7 Remote Portal

In Remote Portal, you can build your own portal server on the network to provide the customized login page for clients. In such scenario, your customized server is called as remote portal server, and AC will be responsible for the communication between the clients and the remote portal server.



Choose the menu **Authentication > Portal Authentication > Remote Portal** to load the following page.

Figure 7-21 Remote Portal

Remote Portal								
<input checked="" type="checkbox"/> Enable <input checked="" type="checkbox"/> Disable <input checked="" type="checkbox"/> Add <input checked="" type="checkbox"/> Delete <input checked="" type="checkbox"/> Search								
<input type="checkbox"/>	ID	Splash Page	SSID	Server Type	Non-sense Authentication	Description	Status	Operation
--	--	--	--	--	--	--	--	--

Here you can view the Remote Portal Authentication information and edit the entries.

Click **+ Add** to add a new entry. There are two authentication server type: Local Authentication Server and Remote Authentication Server.

- Local Authentication Sever

Select Local Authentication Server as the Authentication Server Type, and the following page will appear.

Figure 7-22 Local Authentication Server Page

--	--	--	--	--	--	--	--	--
<p>Status: <input type="radio"/> On <input checked="" type="radio"/> Off</p> <p>Splash Page: <input type="text"/> (1-50 English characters. Letters, digits, underscores or dashes are valid)</p> <p>SSID: <input type="text"/></p> <p>Remote Portal Address: <input type="text"/> (1-100 letters, digits or special characters)</p> <p>Authenticaiton Server Type: <input type="text"/> Local Authentication Server</p> <p>Success Redirect URL: <input type="text"/> (Optional. Enter 1-120 letters, digits or special characters)</p> <p>Fail redirect URL: <input type="text"/> (Optional. Enter 1-120 letters, digits or special characters)</p> <p>Non-sense Authentication: <input type="radio"/> Enable <input checked="" type="radio"/> Disable</p> <p>Description: <input type="text"/> (1-50 characters, optional)</p> <p><b>Note:</b>            1. The remote portal address and the failure redirect URL will join the free authentication policy automatically and no manual configuration is needed.            2. If the remote authentication server is selected, and the server is configured with an online time duration for the users, then this time duration is the time that users can connect to the wireless network for free.</p> <p><input type="button" value="OK"/> <input type="button" value="Cancel"/></p>								

**Status** Specify whether to turn on the remote portal authentication entry.

**Splash Page** Enter the splash page name of the remote portal authentication.

SSID	Specify the SSID that will be enabled with Remote Portal authentication. Note: The SSIDs labeled "Bound" are being used by other authentication entries. If these SSIDs are selected, the original configuration will be replaced by the current configuration.
Remote Portal Address	Enter the address of the server used for remote portal authentication.
Authenticaiton Server Type	Select the server type used for remote portal authentication.
Success Redirect URL	Specify the redirect URL address after successful authentication.
Fail redirect URL	Specify the redirect URL address after the authentication failure.
Non-sense Authentication	If non-sense authentication is enabled, the non-sense authenticated users will pass the authentication automatically when connecting to the wireless network.
Description	Specify a description for the remote portal authentication entry to make it easier to search for and manage.

**Note:**

When Local Authentication Server is selected, you need to add the login information of the allowed clients. For detailed configuration, refer to [7.3 Local User Management](#).

- Remote Authentication Sever

Select Remote Authentication Server as the Authentication Server Type, and the following page will appear.

**Note:**

To configure the remote Radius server ,

Figure 7-23 Remote Authentication Server Page

--	--	--	--	--	--	--	--	--
----	----	----	----	----	----	----	----	----

Status:  On  Off

Splash Page:  (1-50 English characters. Letters, digits, underscores or dashes are valid)

SSID:

Remote Portal Address:   
(1-100 letters, digits or special characters)

Authenticaiton Server Type: Remote Authentication Server ▼

Authentication Server Group:

Free Authentication Timeout: 30 minutes (1-1440)

Success Redirect URL:   
(Optional. Enter 1-120 letters, digits or special characters)

Fail redirect URL:   
(Optional. Enter 1-120 letters, digits or special characters)

Non-sense Authentication:  Enable  Disable

Description:  (1-50 characters, optional)

**Note:**  
 1. The remote portal address and the failure redirect URL will join the free authentication policy automatically and no manual configuration is needed.  
 2. If the remote authentication server is selected, and the server is configured with an online time duration for the users, then this time duration is the time that users can connect to the wireless network for free.

OK Cancel

Status	Specify whether to turn on the remote portal authentication entry.
Splash Page	Enter the splash page name of the remote portal authentication.
VLAN ID	Select the VLAN ID used to remote portal authentication.
Remote Portal Address	Enter the address of the server used for remote portal authentication.
Authenticaiton Server Type	Select the server type used for remote portal authentication. To configure Radius server, refer to <i>Authentication Server</i> .
Authentication Server Group	Select the server group used for remote portal authentication.

<b>Free Authentication Timeout</b>	Set the free online duration for the users. Note: If the remote authentication server is configured with an online time duration for the users, then the time duration set on the server will take effect instead of Free Authentication Timeout set here.
<b>Success Redirect URL</b>	Specify the redirect URL address after successful authentication.
<b>Fail redirect URL</b>	Specify the redirect URL address after the authentication failure.
<b>Non-sense Authentication</b>	If non-sense authentication is enabled, the non-sense authenticated users will pass the authentication automatically when connecting to the wireless network.
<b>Description</b>	Specify a description for the remote portal authentication entry to make it easier to search for and manage.

## 7.3 Local User Management

In Local User Management, you can create and manage local user accounts for the Web authentication feature. Clients need to use the local user accounts to pass the Web authentication.

Choose the menu **Authentication > User Management > Local User Management** to load the following page.

Figure 7-24 Local User Management

**Backup User Information**

**Restore User Information**

File:

Note: Opening csv files in Excel may change a values' format and display. If you edit csv files using Excel, please format the cells into text format first.

**Rule List**

Enable
 Disable
 Add
 Delete
 Search
 Global Search

<input type="checkbox"/>	ID	User Type	User Name	Authentication Timeout	Free Period	MAC Address	Description	Status	Operation
<input type="checkbox"/>	1	Formal User	Guest	2016-12-31	---	---	---	Enabled <input checked="" type="checkbox"/>	<input type="button" value="Edit"/> <input type="button" value="Delete"/>

### Backup User Information

Click **Backup** to backup all the local users' information into a CSV file in ANSI coding format. This file can be restored to the user's list.

### Restore User Information

Add multiple local user entries at a time:

- 1 Save the local user entries as a CSV file with ANSI coding format in the device. You can use the **Backup User Information** function to obtain a CSV file to view the correct format.
- 2 Click **Browse** to select the file path, and then click **Restore** to restore the file.

**Note:**

Using Excel to open the CSV file may cause some numerical format changes, and the number may be displayed incorrectly. If you use Excel to edit the CSV file, please set the cell format as text.

- **Rule List**

Here you can specify and view the local users. Click **+ Add** to add a new entry. There are two user types, including **Formal User** and **Free User**.

### Formal User

You can provide formal users with continuous internet service. When the user's account expires, the account will be invalid.

Figure 7-25 Add a Formal User

<b>User Type</b>	Specify the user type as formal user.
<b>Username</b>	Specify the username. The username should not be the same as any existing one.
<b>Password</b>	Specify the password. Users will be required to enter the username and password when they attempt to access the network.

Authentication Timeout	Specify the authentication timeout for formal users. After the timeout, the users need to log in at the web authentication page again to access the network.
Authentication Period	Specify the authentication period during which the users can log in to the web authentication page.
MAC Address Binding Type	There are three types of MAC binding: <b>No binding</b> , <b>Static Binding</b> and <b>Dynamic Binding</b> . If dynamic binding is selected, the MAC address of the first user that passes the authentication will be bound. If static binding is selected, the MAC address of all users that pass the authentication will be bound.
Maximum Users	Specify the maximum number of users able to use this account to pass the authentication.
Rate Limit (Download)	Select whether to enable download rate limit. With this option enabled, you can specify the limit of download rate.
Rate Limit (Upload)	Select whether to enable upload rate limit. With this option enabled, you can specify the limit of upload rate.
Traffic Limit	Select whether to enable traffic limit. With this option enabled, you can specify the total traffic limit in a period of time. Once the limit is reached in one period, the client cannot access the network until the next period. The period options include <b>Every Day</b> , <b>Every Week</b> , <b>Every Month</b> and <b>All Authentication Time</b> .
Name	Specify the user's name (optional).
Telephone	Specify the user's telephone number (optional).
Description	Enter a description for the user (optional).
Status	Specify whether to enable this account.

## Free User

You can provide free users with internet service for a short time (in minutes). The account can be reused. When the time expires, the user can log in to the authentication page again and can be re-authenticated.

Figure 7-26 Add a Free User

--	--	--	--	--	--	--	--	--	--
User Type:	Free User ▼								
Username:	<input type="text"/> (1-100 letters, digits or special characters)								
Password:	<input type="password"/> (1-100 letters, digits or special characters)								
Authentication Period:	00:00-24:00 (XX:XX-XX:XX)								
Free Period:	30 minutes (1-1440)								
Maximum Users:	1 (1-2048)								
Rate Limit(Download):	<input type="radio"/> On <input checked="" type="radio"/> Off								
Rate Limit(Upload):	<input type="radio"/> On <input checked="" type="radio"/> Off								
Traffic Limit:	<input type="radio"/> On <input checked="" type="radio"/> Off								
Description:	<input type="text"/> (1-50 characters, optional)								
Status:	<input checked="" type="radio"/> On <input type="radio"/> Off								
<input type="button" value="OK"/> <input type="button" value="Cancel"/>									

User Type	Specify the user type as free user.
Username	Specify the username. The username should not be the same as any existing one.
Password	Specify the password. Users will be required to enter the username and password when they attempt to access the network.
Authentication Period	Specify the authentication period during which the users can log in to the web authentication page.
Free Period	Specify the free period for the users to be online.
Maximum Users	Specify the maximum number of users able to use this account to pass the authentication.
Rate Limit (Download)	Select whether to enable download rate limit. With this option enabled, you can specify the limit of download rate.
Rate Limit (Upload)	Select whether to enable upload rate limit. With this option enabled, you can specify the limit of upload rate.
Traffic Limit	Select whether to enable traffic limit. With this option enabled, you can specify the total traffic limit in a period of time. Once the limit is reached in one period, the client cannot access the network until the next period. The period options include <b>Every Day</b> , <b>Every Week</b> , <b>Every Month</b> and <b>All Authentication Time</b> .
Description	Optional: Enter a description for the user.
Status	Specify whether to turn on authentication.

## 7.4 Voucher Management

You can create voucher codes in batch on the Create Voucher page and manage them conveniently on the Manage Voucher page.

### 7.4.1 Create Voucher

Choose the menu **Authentication > Voucher Management > Create Voucher** to load the following page.

Figure 7-27 Create Voucher

The screenshot shows a web form titled "Create Voucher". It contains the following fields and options:

- Code Length:** A text input field with a range of (6-10).
- Amount:** A text input field with a range of (1-20000).
- Type:** A dropdown menu currently set to "Single Use".
- Duration Time:** A text input field with a range of minutes (1-1440).
- Rate Limit (Download):** A checkbox labeled "Enable".
- Rate Limit (Upload):** A checkbox labeled "Enable".
- Traffic Limit:** A checkbox labeled "Enable".
- Description:** A text input field with a range of (1-50 characters, optional).

A "Save" button is located at the bottom left of the form.

Specify the parameters of the vouchers to be created and click **OK**.

<b>Code Length</b>	Specify the length of the voucher codes to be created.
<b>Amount</b>	Specify the number of voucher codes to be created.
<b>Type</b>	Select the type of the voucher codes to be created. There are two types: Single Use and Multi Use. Single Use allows only one client to pass the authentication with one voucher code. Multi Use allows several clients to pass the authentication with one voucher code.
<b>Max Users</b>	If Multi Use is selected, specify the maximum number of the clients who can use the same voucher code to pass the authentication.
<b>Duration Time</b>	Specify the permitted online time of clients who have passed the authentication.
<b>Rate Limit (Download)</b>	Select whether to enable download rate limit. With this option enabled, you can specify the limit of download rate.
<b>Rate Limit (Upload)</b>	Select whether to enable upload rate limit. With this option enabled, you can specify the limit of upload rate.
<b>Traffic Limit</b>	Specify the total traffic limit for one voucher. Once the limit is reached, the client can no longer access the network using the voucher.



Description	Specify a description for the voucher codes to make them easier to search for and manage.
-------------	---

## 7.4.2 Manage Voucher

Choose the menu **Authentication > Voucher Management > Manage Voucher** to load the following page.

Figure 7-28 Manage Voucher

Voucher Management							
Print All Unused            Delete            Refresh            Search            Global Search							
<input type="checkbox"/>	ID	Code	Create Time	Description	Duration	Status	Operation
<input type="checkbox"/>	1	677946	04/12/2017 01:46:27	---	40 Min	Valid for 3 online User(s)	
<input type="checkbox"/>	2	724214	04/12/2017 01:44:20	---	30 Min	Valid for 1 online User(s)	
<input type="checkbox"/>	3	204704	04/12/2017 01:44:20	---	30 Min	Valid for 1 online User(s)	

The above table displays the information of the current vouchers. You can print and distribute them to the users. Also, you can manage the vouchers, such as deleting the vouchers and setting the vouchers to be expired.

Code	Displays the voucher code. Clients will be required to enter the voucher code when they attempt to access the network.
------	--

Create Time	Displays the time when the voucher code is created.
-------------	---

Description	Displays the description for the voucher code.
-------------	--

Duration	Displays the permitted online time of the clients who have passed the authentication.
----------	---

Status	Displays whether the code is valid or not, and if valid, how many clients are permitted to pass the authentication.
--------	---

Operation	: Click this button to print the codes created in the same batch. : Click this button to delete the voucher code. : Click this button to set the voucher code to be expired, which means that the voucher code cannot be used to pass the authentication.
-----------	---

## 7.5 Authentication Server

AC supports external Radius server. When clients start the authentication process, the AC will forward user information to the external authentication server, and the server will authenticate the user. To use this feature, follow the steps below:

- 1 Configure the Radius Server. Choose the menu **Authentication > Authentication Server > Radius Server**.
- 2 Configure the Server group. Choose the menu **Authentication > Authentication Server > Authentication Server Group**.

## 7.5.1 Radius Server

Choose the menu **Authentication > Authentication Server > Radius Server** to load the following page.

Figure 7-29 Radius Server

Radius Server							
<input type="checkbox"/>	ID	Name	Address	Authentication Port	Billing Port	Authentication Type	Operation
--	--	--	--	--	--	--	--

+ Add   
 - Delete   
 🔍 Search

Here you can add, edit or delete an external radius server.

Click + Add to add a new entry.

Figure 7-30 Add a Radius Serve

Server Name:  (1-50 characters)

Server Address:   
(IP Address or Domain name, 1-250 characters)

Authentication Port:  (1024-65535)

Billing Port:  (0, 1024-65535)

Share Key:  (1-120 characters)

Retry Count:  (0-10)

Timeout Interval:  (1-60 seconds)

NAS IP Address:  (Optional)

Authentication Type:

<b>Server Name</b>	Specify a name for the Radius server.
<b>Server Address</b>	Specify the address of the server. It should be an IPv4 address or a DNS domain.
<b>Authentication Port</b>	Specify a port for the server to monitor the authentication packets.

Billing Port	Specify a port for the server to monitor the billing packets. 0 means disable the billing function.
Share Key	Specify a shared key for the Radius server.
Retry Count	If no reply is received after the client sends a connect request, it will keep resending the request. Specify the number of times the client is allowed to resend the request.
Timeout Interval	Specify the timeout interval after the client sends a request packet.
NAS IP Address	Specify the NAS IP address for the authentication. Generally, it is the address by which the AC and Radius server communicate. This field can be left empty.
Authentication Type	The authentication type includes PAP, CHAP, MSCHAP and MSCHAPv2.

## 7.5.2 Authentication Server Group

Choose the menu **Authentication > Authentication Server > Authentication Server Group** to load the following page.

Figure 7-31 Server Group

Authentication Server Group

Add
 Delete
 Search

<input type="checkbox"/>	ID	Group Name	Authentication Type	Description	Operation
--	--	--	--	--	--

Here you can view or edit the server group.

Click **Add** to add a new entry.

Figure 7-32 Add a Serve Group

Group Name:  (1-50 characters)

Authentication Type:  RADIUS

Main Server:  --- ▼

Standby Server:  --- ▼ (Optional)

Recovery Time:  30 (30-1440 Minutes)

Description:  (1-50 characters, optional)

Group Name	Specify a group name for the authentication server. The group name should not be the same as the existing one.
Authentication Type	Select the authentication server type. Only Radius server is supported so far.

Main Server	Select the main server for the group. The main server will have higher priority.
Standby Server	Select the standby server for the group. If the main server malfunctions, the standby server will come into use.
Recovery Time	Specify the time interval after the main server malfunctions for reconnection.
Description	Specify a description for the authentication server group.

## 7.6 Authentication Config

### 7.6.1 Free Authentication Policy

Free authentication policy is used to provide free resources for clients before they pass the portal authentication.

Choose the menu **Authentication > Portal Authentication > Free Authentication Policy** to load the following page.

Figure 7-33 Free Authentication Policy

Free Authentication Policy

✔ Enable
✘ Disable
➕ Add
➖ Delete
🔍 Search

<input type="checkbox"/>	ID	Strategy Name	URL Address	Source IP Range	Destination IP Range	Source Port	Destination Port	Protocol	Description	Status	Operation
--	1	dhcp client	---	---	---	68-68	67-67	UDP	---	Enabled	---
--	2	dhcp server	---	---	---	67-67	68-68	UDP	---	Enabled	---
--	3	dns client	---	---	---	---	53-53	UDP	---	Enabled	---
--	4	dns server	---	---	---	53-53	---	UDP	---	Enabled	---

Here you can view the Free Authentication Policy information and edit the entries. Entry 1 to entry 4 are default free authentication policies and cannot be edited.

Click  **Add** to add a new entry. There are two Match Modes, including Five Tuple Type and URL Type.

■ **Five Tuple Type**

Five Tuple Type is configured based on the IP address range, MAC address, VLAN ID, port and protocol. It is recommended to select Five Tuple Type when there are many parameters to be configured in the free authentication policy.

Figure 7-34 Five Tuple Type

<b>Strategy Name</b>	Specify a name for the free authentication policy entry.
<b>Match Mode</b>	Specify a match mode for the free authentication policy.
<b>Source IP Range</b>	Specify the source IP address and subnet mask of the free authentication policy entry.
<b>Source MAC Address</b>	Specify the source MAC address of the free authentication policy entry.
<b>Source VLAN</b>	Specify the source VLAN ID of the free authentication policy entry.
<b>Source Port</b>	Specify the source port range of the free authentication policy entry.
<b>Destination IP Range</b>	Specify the destination IP address and subnet mask of the free authentication policy entry.
<b>Destination Port</b>	Specify the destination source MAC address of the free authentication policy entry.
<b>Protocol</b>	Specify the service protocol of the free authentication policy entry.

Description	Specify a description for the free authentication policy entry to make it easier to search for and manage.
Status	Specify whether to turn on the free authentication policy.

### ■ URL Type

URL Type is configured based on the URL address, IP address range, MAC address and VLAN ID. It is recommended to select URL Type when the URL address is already known.

Figure 7-35 URL Type

Strategy Name:  (1-50 characters)

Match Mode:  ▼

URL Address:  (1-128 characters)

Source IP Range:  /  (Optional)

Source MAC Address:  (XX-XX-XX-XX-XX-XX, optional)

Source VLAN:  (1-4094, optional)

Description:  (1-50 characters, optional)

Status:  On  Off

**Note:**  
 1. The empty strategy means all sources are allowed to visit.  
 2. Only when one of the source port or the destination port is configured, can the protocol take effect.

Strategy Name	Specify a name for the free authentication policy entry.
Match Mode	Specify a match mode for the free authentication policy.
URL Address	Specify the URL address for the URL type of free authentication policy.
Source IP Range	Specify the source IP address and subnet mask of the free authentication policy entry.
Source MAC Address	Specify the source MAC address of the free authentication policy entry.
Source VLAN	Specify the source VLAN ID of the free authentication policy entry.
Protocol	Specify the service protocol of the free authentication policy entry.
Description	Specify a description for the free authentication policy entry to make it easier to search for and manage.
Status	Specify whether to turn on the free authentication policy.

### Note:

- The empty strategy means all sources are allowed to visit.

- Only when one of the source port or the destination port is configured, can the protocol take effect.

## 7.6.2 Authentication Parameters

Choose the menu **Authentication > Portal Authentication > Authentication Parameters** to load the following page.

Figure 7-36 Authentication Config

**Authentication Parameters**

Authentication Aging

Aging Time:  (5-30 minutes)

Portal Authentication Port:  (80, 1024-65535)

Here you can configure and view the global parameters for the authentication.

<b>Authentication Aging</b>	Specify whether to enable authentication aging. If the authenticated users leave the wireless network within the aging time, they could reconnect to the AP without re-authentication. If the leave time is longer than the aging time, authentication is required again for users to connect to the AP.
<b>Aging Time</b>	Enter the aging time within which the users could reconnect to the AP without authentication. The default value is 5.
<b>Portal Authentication Port</b>	Specify the service port for portal authentication. The default setting is 8080. It should not be the same as other occupied service ports.

## 7.7 Applications

### 7.7.1 Application for Web Authentication

#### ▪ Network Requirements

A hotel wants to offer customers internet access and push hotel advertisements through the Web authentication page. The clients can access the network only after passing the Web authentication.

In this case, the hotel can use the local authentication server to authenticate the clients and use the advertisement feature to display the advertisement pictures to the clients.

## ■ Network Topology

Figure 7-37 Network Topology

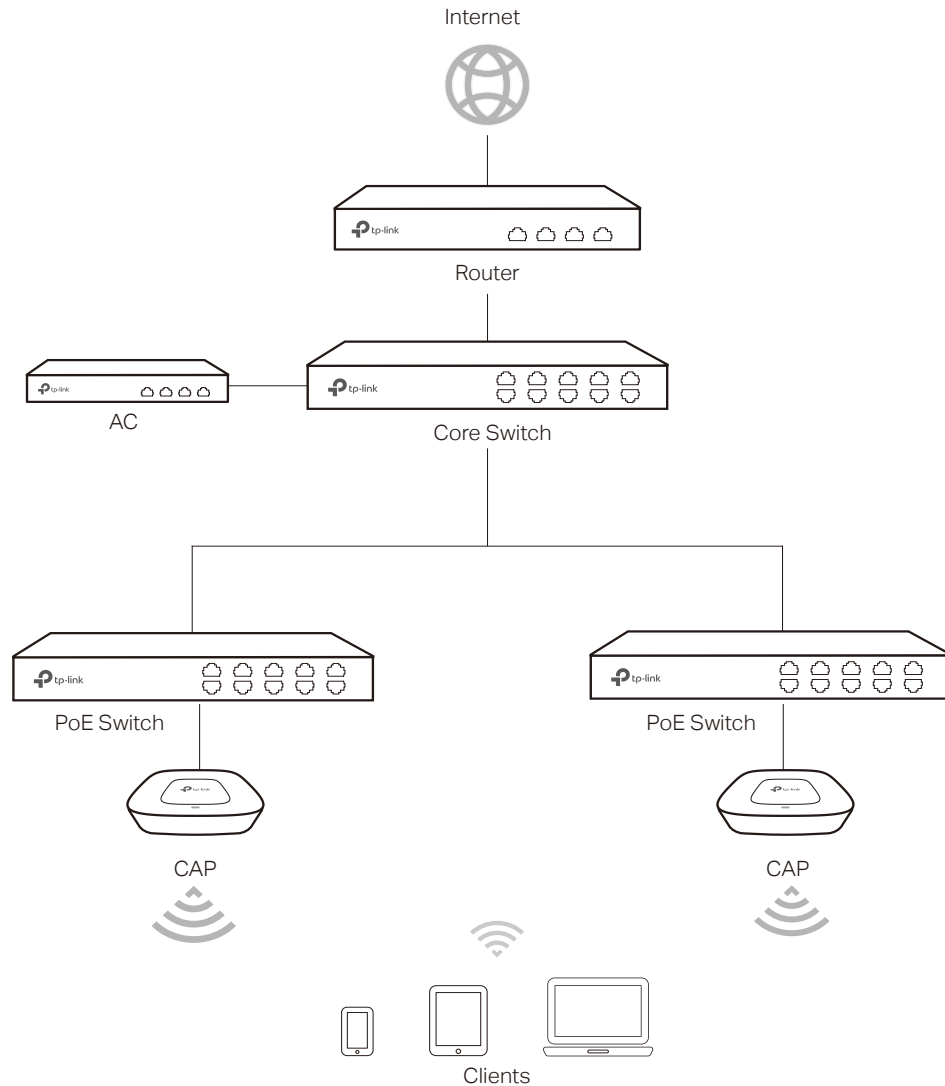

## ■ Configuration Steps

### 1 Create SSID

Create an SSID for the clients in the **Wireless** module.

### 2 Configure the Splash Page

Choose the menu **Authentication > Portal Authentication > Splash Page**. Click **+ Add** to add a new entry.

Set the Authentication Type as **Web Authentication** and set the related parameters. Here you can upload the logo image and a promotional image of the hotel to the device.



Figure 7-38 Splash Page Configurations

The configuration interface is divided into two main sections: configuration parameters on the left and a preview on the right.

**Configuration Parameters:**

- Page Name:** Web (1-50 English characters. Letters, digits, underscores or dashes are valid)
- Authentication Type:** Web Authentication
- Page Title:** xx Hotel (1-50 characters)
- Background:**  Solid Color  Picture
- Background Picture:** Upload Success. (Optional)
- Logo:** Upload Success.
- Welcome Information:** Welcome to xx Hotel (1-26 characters)
- Welcome Information Color:** (RGB Value)
- Copyright:** Copyright 2017 (1-50 characters)
- Copyright Information Color:** (RGB Value)
- Description:** (1-50 characters, optional)
- Input Box:**
- Input Box Frame Color:** (RGB Value)
- Button:**
- Button Position:** Middle
- Button Color:** (RGB Value)
- Button Text Color:** (RGB Value)

**Note:**  
1. If this entry is referenced, the Page Name and Authentication Type cannot be changed.

**Preview:** The preview shows a splash page for a 'HOTEL' with a background image of a hotel room. The page includes a 'HOTEL' logo, the text 'Welcome to xx Hotel', and a login form with fields for 'Username' and 'Password', and a 'Login' button. The page also displays 'Copyright 2017' at the bottom.

### 3 Configure the Web Authentication

Choose the menu **Authentication > Portal Authentication > Web Authentication**. Click **+ Add** to add a new entry.

Enable **Web Authentication** and set the related parameters.

Figure 7-39 Web Authentication Configurations

Status:  On  Off

SSID: xx Hotel\_Web Authentication ▼

Splash Page: Web ▼

Authenticaiton Server Type: Local Authentication Server ▼

Success Redirect URL: www.xxHotel.com

(Optional. Enter 1-120 letters, digits or special characters)

Fail redirect URL:

(Optional. Enter 1-120 letters, digits or special characters)

Non-sense Authentication:  Enable  Disable

Advertisement:  Enable  Disable

Description: Web Authentication (1-50 characters, optional)

**Note:**  
1. If you have configured the failure redirect URL, the URL will join the free authentication policy automatically and no manual configuration is needed.  
2. If the remote authentication server is selected, and the server is configured with an online time duration for the users, then this time duration is the time that users can connect to the wireless network for free.

OK Cancel

#### 4 Add Authentication Accounts

After Web Authentication configuration, we still need to add user accounts to the device.

In this example, we create accounts to meet the following requirements: Each room is offered with a free account, and up to three clients are able to use this account to pass the authentication at the same time. The free time is two hours, and the client needs to restart the authentication after the time expires.

Choose the menu **Authentication > Local User Management > Local User Management**.  
Click **+ Add** to add a new entry.  
Set the related parameters as shown below.

Figure 7-40 Add a Free Account

User Type:	Free User	
Username:	user1	(1-100 letters, digits or special characters)
Password:	12345678	(1-100 letters, digits or special characters)
Authentication Period:	00:00-24:00	(XX:XX-XX:XX)
Free Period:	120	minutes (1-1440)
Maximum Users:	3	(1-2048)
Rate Limit(Download):	<input type="radio"/> On <input checked="" type="radio"/> Off	
Rate Limit(Upload):	<input type="radio"/> On <input checked="" type="radio"/> Off	
Traffic Limit:	<input type="radio"/> On <input checked="" type="radio"/> Off	
Description:		(1-50 characters, optional)
Status:	<input checked="" type="radio"/> On <input type="radio"/> Off	
<input type="button" value="OK"/> <input type="button" value="Cancel"/>		

## 7.7.2 Application for Onekey Online

### Network Requirements

A hotel wants to offer customers free internet access. Customers can access the internet without providing any information. In this case, the hotel can use **Onekey Online** to meet the requirements.

#### ■ Network Topology

Figure 7-41 Network Topology

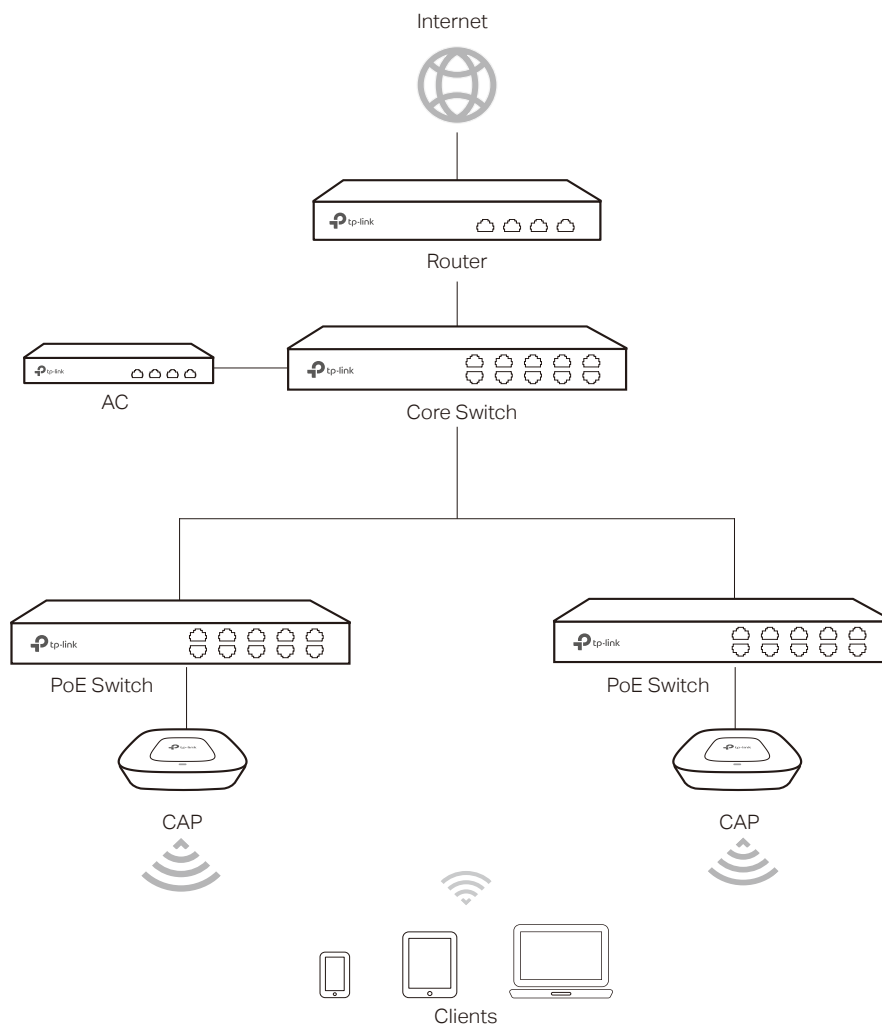

#### ■ Configuration Steps

##### 1 Create SSID

Create an SSID for the clients in the **Wireless** module.

##### 2 Configure the Splash Page

Choose the menu **Authentication > Portal Authentication > Splash Page**. Click **+ Add** to add a new entry. Set the Authentication Type as **Onekey Online** and set the other related parameters.

Figure 7-42 Splash Page Configurations

### 3 Configure Onekey Online

In this case, we set the free online time as 30 minutes, and the client needs to restart the connection after the time expires.

Choose the menu **Authentication > Portal Authentication > Onekey Online**. Click **+ Add** to add a new entry. Turn on the Onekey Online and set the related parameters.

Figure 7-43 Onekey Online Configurations

## 7.7.3 Application for Voucher

### ■ Network Requirements

A hotel wants to offer customers internet access. To access the internet, the customers should provide the correct codes which are got from the hotel to pass the authentication.

In this case, the hotel can use the Voucher feature to generate voucher codes and assign these codes to the clients. AC can use the built-in authentication server to authenticate the clients.

## ■ Network Topology

Figure 7-44 Network Topology

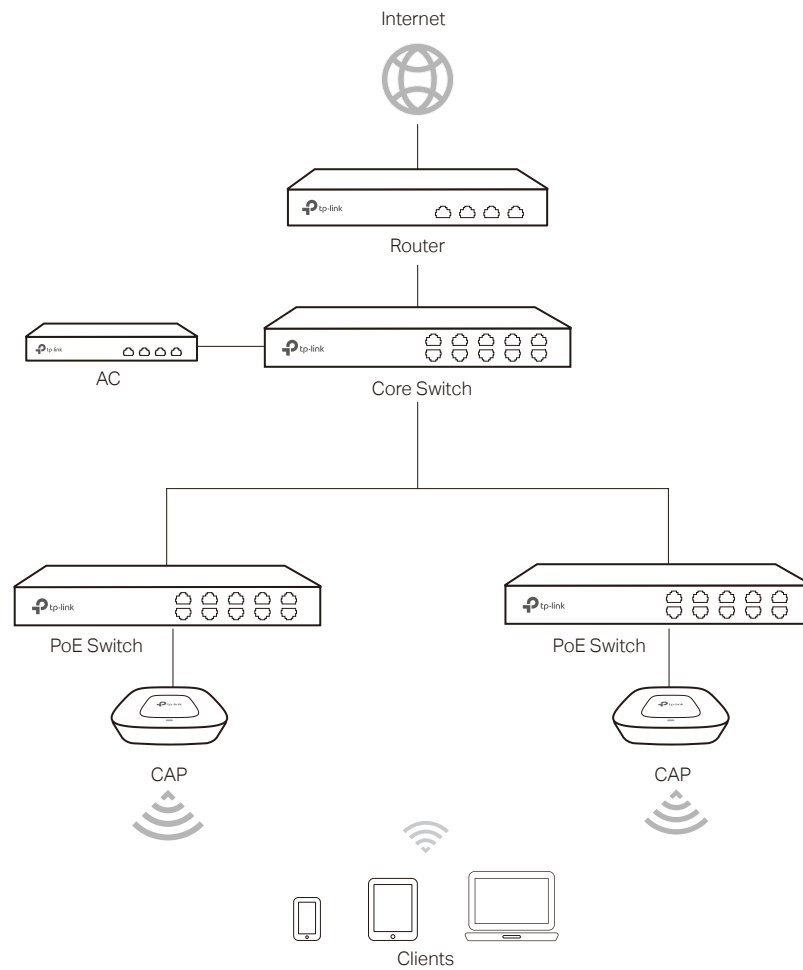

## ■ Configuration Steps

### 1 Create SSID

Create an SSID for the clients in the **Wireless** module.

### 2 Configure the splash page.

Choose the menu **Authentication > Portal Authentication > Splash Page**. Click **+ Add** to add a new entry.

Set the Authentication Type as **Voucher** and set the related parameters.

Figure 7-45 Splash Page Configurations

Page Name:  (1-50 English characters. Letters, digits, underscores or dashes are valid)

Authentication Type:

Page Title:  (1-50 characters)

Background:  Solid Color  Picture

Background Picture:  Success. (Optional)

Logo:  Success.

Welcome Information:  (1-26 characters)

Welcome Information Color:  (RGB Value)

Copyright:  (1-50 characters)

Copyright Information Color:  (RGB Value)

Description:  (1-50 characters, optional)

Input Box:

Input Box Frame Color:  (RGB Value)

Button

Button Position:

Note: The positions of Input Box and Button will be set as a whole.

Button Color:  (RGB Value)

Button Text Color:  (RGB Value)

**Note:**  
1. If this entry is referenced, the Page Name and Authentication Type cannot be changed.

### 3 Configure Voucher Authentication

Choose the menu **Authentication > Portal Authentication > Voucher**. Click **+ Add** to add a new entry. Turn on the Voucher feature and set the related parameters. Click **OK**.

Figure 7-46 Voucher Configurations

Status:  On  Off

SSID:

Splash Page:

Success Redirect URL:

(Optional. Enter 1-120 letters, digits or special characters)

Fail redirect URL:

(Optional. Enter 1-120 letters, digits or special characters)

Non-sense Authentication:  Enable  Disable

Advertisement:  Enable  Disable

Description:  (1-50 characters, optional)

**Note:**  
1. If you have configured the failure redirect URL, the URL will join the free authentication policy automatically and no manual configuration is needed.

## 4 Create Vouchers

Choose the menu **Authentication > Portal Authentication > Voucher Management > Create Voucher**. Specify the related parameters and click **Save**.

Figure 7-47 Create Vouchers

**Create Voucher**

Code Length:  (6-10)

Amount:  (1-20000)

Type:  ▼

Duration Time:  minutes (1-1440)

Rate Limit (Download):  Enable

Rate Limit (Upload):  Enable

Traffic Limit:  Enable

Description:  (1-50 characters, optional)

## 5 Print Vouchers





































Choose the menu **Authentication > Portal Authentication > Voucher Management > Manage Voucher**. Click  **Print All Unused** to export the voucher codes.

Figure 7-48 View Vouchers

**Voucher Management**

 Print All Unused 
  Delete 
  Refresh 
  Search 
  Global Search

<input type="checkbox"/>	ID	Code	Create Time	Description	Duration	Status	Operation
<input type="checkbox"/>	1	469940	05/04/2017 02:54:06	---	30 Min	Valid for 1 online User(s)	  
<input type="checkbox"/>	2	021366	05/04/2017 02:54:06	---	30 Min	Valid for 1 online User(s)	  
<input type="checkbox"/>	3	287114	05/04/2017 02:54:06	---	30 Min	Valid for 1 online User(s)	  
<input type="checkbox"/>	4	677029	05/04/2017 02:54:06	---	30 Min	Valid for 1 online User(s)	  
<input type="checkbox"/>	5	129644	05/04/2017 02:54:06	---	30 Min	Valid for 1 online User(s)	  
<input type="checkbox"/>	6	381276	05/04/2017 02:54:06	---	30 Min	Valid for 1 online User(s)	  
<input type="checkbox"/>	7	389526	05/04/2017 02:54:06	---	30 Min	Valid for 1 online User(s)	  
<input type="checkbox"/>	8	144865	05/04/2017 02:54:06	---	30 Min	Valid for 1 online User(s)	  
<input type="checkbox"/>	9	323135	05/04/2017 02:54:06	---	30 Min	Valid for 1 online User(s)	  
<input type="checkbox"/>	10	057911	05/04/2017 02:54:06	---	30 Min	Valid for 1 online User(s)	  

The voucher codes in the table will be exported as the following figure shows. You can print these codes and give them to your customers.



Figure 7-49 Print Vouchers

<p><b>469940</b> Valid for 30 Min With 1 online User(s)</p>	<p><b>021366</b> Valid for 30 Min With 1 online User(s)</p>	<p><b>287114</b> Valid for 30 Min With 1 online User(s)</p>
<p><b>677029</b> Valid for 30 Min With 1 online User(s)</p>	<p><b>129644</b> Valid for 30 Min With 1 online User(s)</p>	<p><b>381276</b> Valid for 30 Min With 1 online User(s)</p>
<p><b>389526</b> Valid for 30 Min With 1 online User(s)</p>	<p><b>144865</b> Valid for 30 Min With 1 online User(s)</p>	<p><b>323135</b> Valid for 30 Min With 1 online User(s)</p>
<p><b>057911</b> Valid for 30 Min With 1 online User(s)</p>	<p><b>450677</b> Valid for 30 Min With 1 online User(s)</p>	<p><b>306268</b> Valid for 30 Min With 1 online User(s)</p>
<p><b>872269</b> Valid for 30 Min With 1 online User(s)</p>	<p><b>892106</b> Valid for 30 Min With 1 online User(s)</p>	<p><b>711512</b> Valid for 30 Min With 1 online User(s)</p>

## 7.7.4 Application for SMS

- **Network Requirements**

A hotel wants to offer customers internet access using the Twilio API service. The customer needs to get authentication code using a mobile phone and access the network with the authentication code.

In this case, the hotel can use the SMS feature to authenticate the clients.

## ■ Network Topology

Figure 7-50 Network Topology

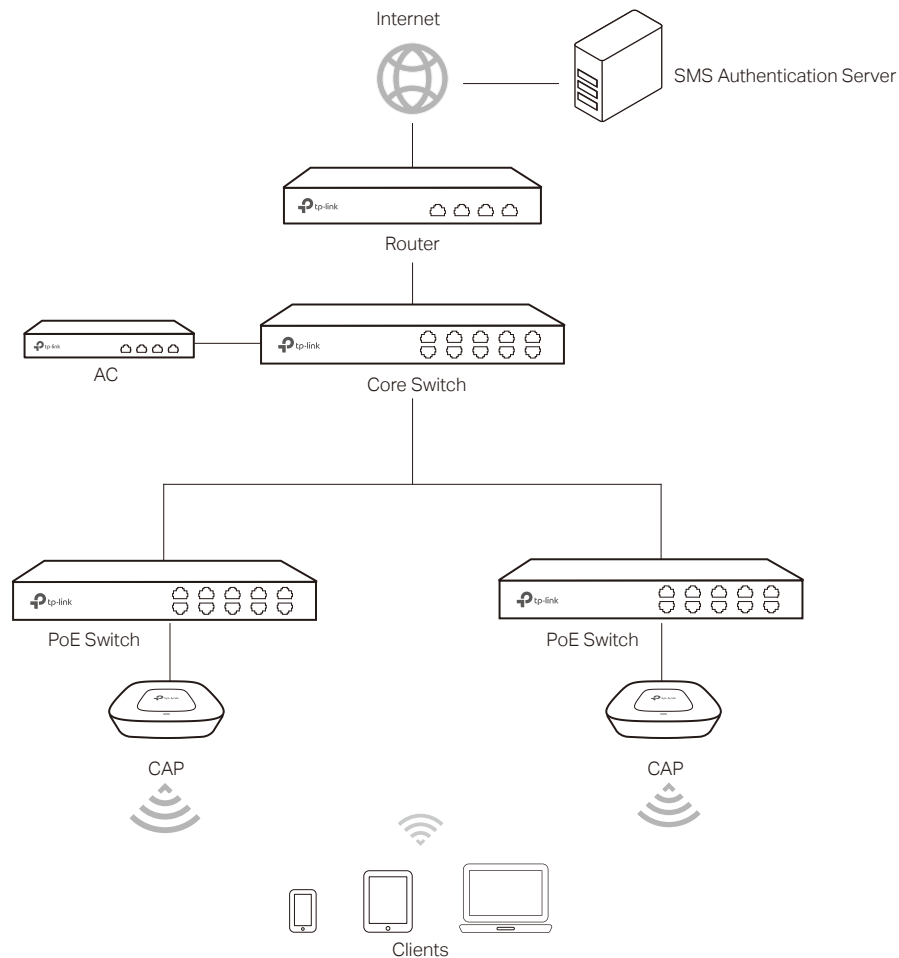

## ■ Configuration Steps

### 1 Create SSID

Create an SSID for the clients in the **Wireless** module.

### 2 Configure the splash page

Choose the menu **Authentication > Portal Authentication > Splash Page**. Click **+ Add** to add a new entry.

Set the Authentication Type as **SMS** and set the related parameters.

Figure 7-51 Splash Page Configurations

Page Name: SMS (1-50 English characters. Letters, digits, underscores or dashes are valid)

Authentication Type: SMS

Page Title: xx Hotel (1-50 characters)

Background:  Solid Color  Picture

Background Picture: Upload Success. (Optional)

Logo: Upload Success.

Welcome Information: Welcome to xx Hotel (1-26 characters)

Welcome Information Color: (RGB Value)

Copyright: Copyright 2017 (1-50 characters)

Copyright Information Color: (RGB Value)

Description: (1-50 characters, optional)

Input Box:

Input Box Frame Color: (RGB Value)

Button:

Button Position: Middle

Note: The positions of Input Box and Button will be set as a whole.

Button Color: (RGB Value)

Button Text Color: (RGB Value)

**Note:**  
1. If this entry is referenced, the Page Name and Authentication Type cannot be changed.

OK Cancel

### 3 Register an Twilio account

Go to the official website of Twilio and follow the instructions to create an account.

Figure 7-52 Register Account

twilio

Sign up for free

Peter Killen

Company Name (optional)

123456@google.com

Strong

WHICH PRODUCT DO YOU PLAN TO USE FIRST?  
SMS

WHAT ARE YOU BUILDING?  
I don't have a project in mind yet

CHOOSE YOUR LANGUAGE  
I'm not a developer

Get Started By clicking the button, you agree to our [legal policies](#).

Already have an account? [Login](#)

© 2017 Twilio, Inc. All rights reserved. [Privacy Policy](#) | [Terms of Service](#)

### 4 Apply for Twilio Service and get the related information

After successful login to Twilio, you need to buy the service for SMS according to the instructions on the website. Then get the account information, including ACCOUNT SID, AUTH TOKEN and Phone number.

Figure 7-53 Account Information\_SID and Auth Token

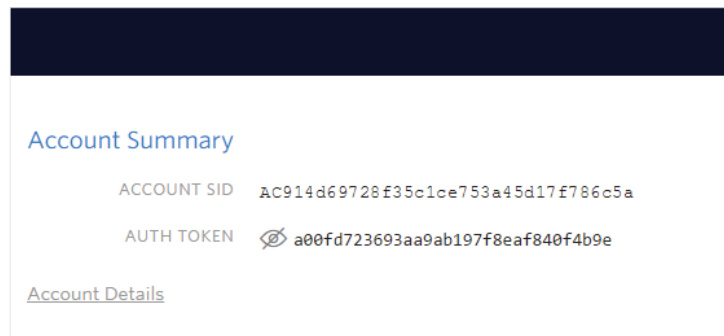
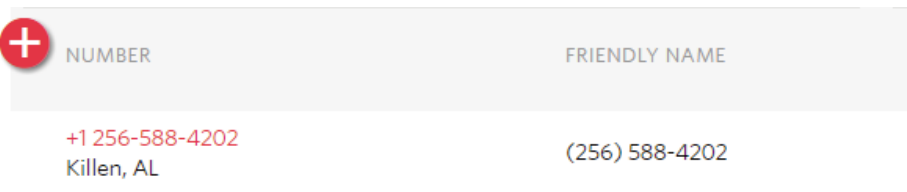

Figure 7-54 Account Information\_Phone Number



## 5 Configure the SMS Authentication

Choose the menu **Authentication > Portal Authentication > SMS**. Click **+ Add** to add a new entry.

Figure 7-55 SMS Authentication Page

The screenshot shows a configuration form for SMS authentication. It includes the following fields and options:

- Status:  On  Off
- SSID: xx Hotel
- Splash Page: xxHotel\_SMS
- We provide Twilio API service. Please configure your account information:
- Twilio SID: AC914d69728f35c1ce753a45d17f7
- Authentication Token: a00fd723693aa9ab197f8eaf840f4
- Phone Number: +12565884202 (e.g., +16175551212)
- Free Authentication Timeout: 60 minutes (1-1440)
- Advertisement:  Enable  Disable
- Description: (1-50 characters, optional)

At the bottom, there are "OK" and "Cancel" buttons.

Enable SMS and configure the related parameters. You can directly paste the Twilio account information from the website to this page. Click **OK**.

## 7.7.5 Application for Facebook

### ■ Network Requirements

A hotel wants to offer customers internet access and push hotel advertisement through the Facebook Page of the hotel. And The customers will be redirected to the Facebook Page after checking in.

In this case, the hotel can use the Facebook authentication feature to authenticate the clients.

### ■ Network Topology

Figure 7-56 Network Topology

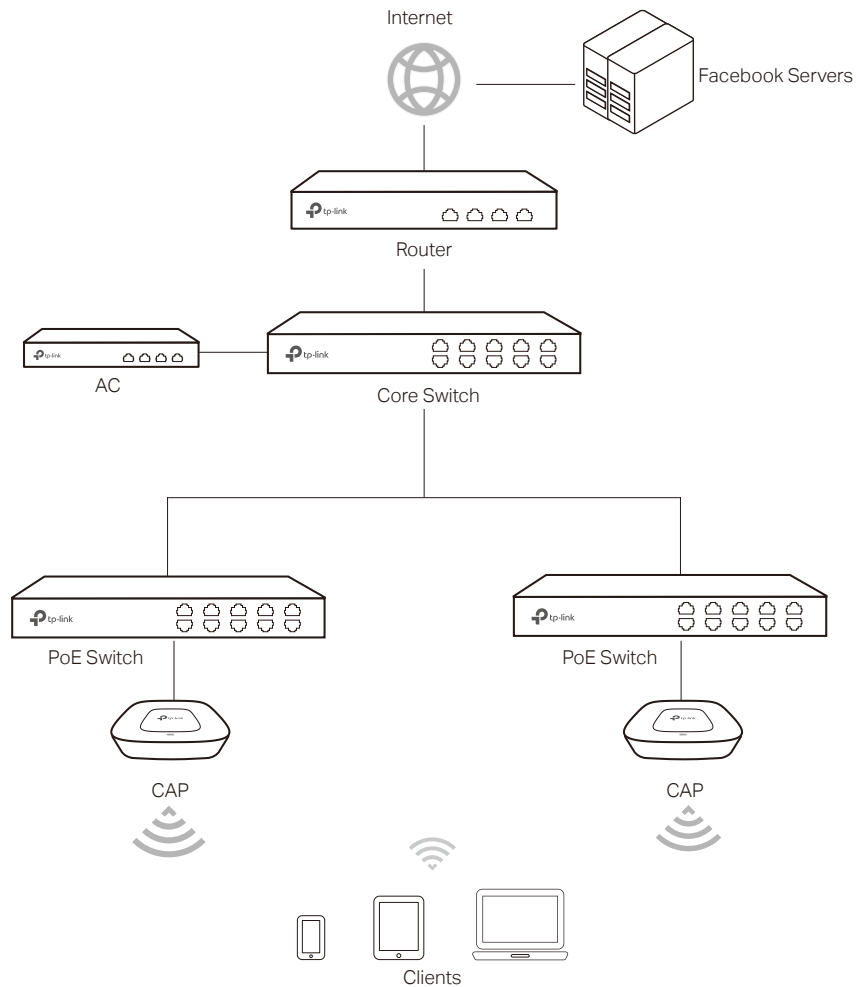

### ■ Configuration Steps

#### 1 Create the Facebook Page

Log in to Facebook and create a Facebook Page with advertisements of the hotel.

#### 2 Create SSID

Create an SSID for the clients in the **Wireless** module.

#### 3 Configure the Facebook Authentication

Choose the menu **Authentication > Portal Authentication > Facebook**. Click **+ Add** to add a new entry.

Figure 7-57 Facebook Authentication Page

The screenshot shows a configuration window for Facebook authentication. It includes the following fields and controls:

- Status:** Radio buttons for  On and  Off.
- SSID:** A dropdown menu currently showing "xxHotel\_Facebook".
- Configuration:** A button labeled "Configuration".
- Facebook Page:** A dropdown menu currently showing "None".
- Description:** A text input field with a placeholder "(1-50 characters, optional)".
- Buttons:** "OK" and "Cancel" buttons at the bottom left.

Click the **Configuration** button and specify the Facebook Page and the related parameters. Click **Save Settings** and close this window.

Figure 7-58 Facebook Configurations

The screenshot shows the "Facebook Wi-Fi Configuration" page for an AC500 v1.0 device (ID: 20170502023400). The page is divided into several sections:

- Facebook Page:** A dropdown menu showing "xx Hotel". Below it, a note states: "To use Facebook Wi-Fi you need to be the admin of a local business Page that has a valid location associated with it."
- Bypass Mode:** Two radio button options:  Skip check-in link [?] and  Require Wi-Fi code [?].
- Session Length:** A dropdown menu showing "Five hours". Below it, a note states: "Select the length of time your customers will have Wi-Fi for after they check in."
- Terms of Service:** A checkbox labeled "Optional: Add your own Terms of Service [?]" which is currently unchecked.
- Footer:** A "Visit Help Center" link on the left and a blue "Save Settings" button on the right.

Verify the configuration result and click **OK**.

Figure 7-59 Facebook Configuration Result

--	--	--	--	--	--	--	--
Status:	<input checked="" type="radio"/> On	<input type="radio"/> Off					
SSID:	xxHotel_Facebook ▼						
Configuration:	Configuration						
Facebook Page:	xx Hotel						
Description:							(1-50 characters, optional)
OK		Cancel					

## 7.7.6 Application for Remote Portal

### ■ Network Requirements

A hotel wants to offer customers internet access and use the remote portal server to push hotel advertisement through the login page. The clients can access the network only after pass the authentication.

In this case, the hotel can use the Remote Portal feature. The remote portal server provides login and authentication page, and the local server of the AC authenticates the clients.

## ■ Network Topology

Figure 7-60 Network Topology

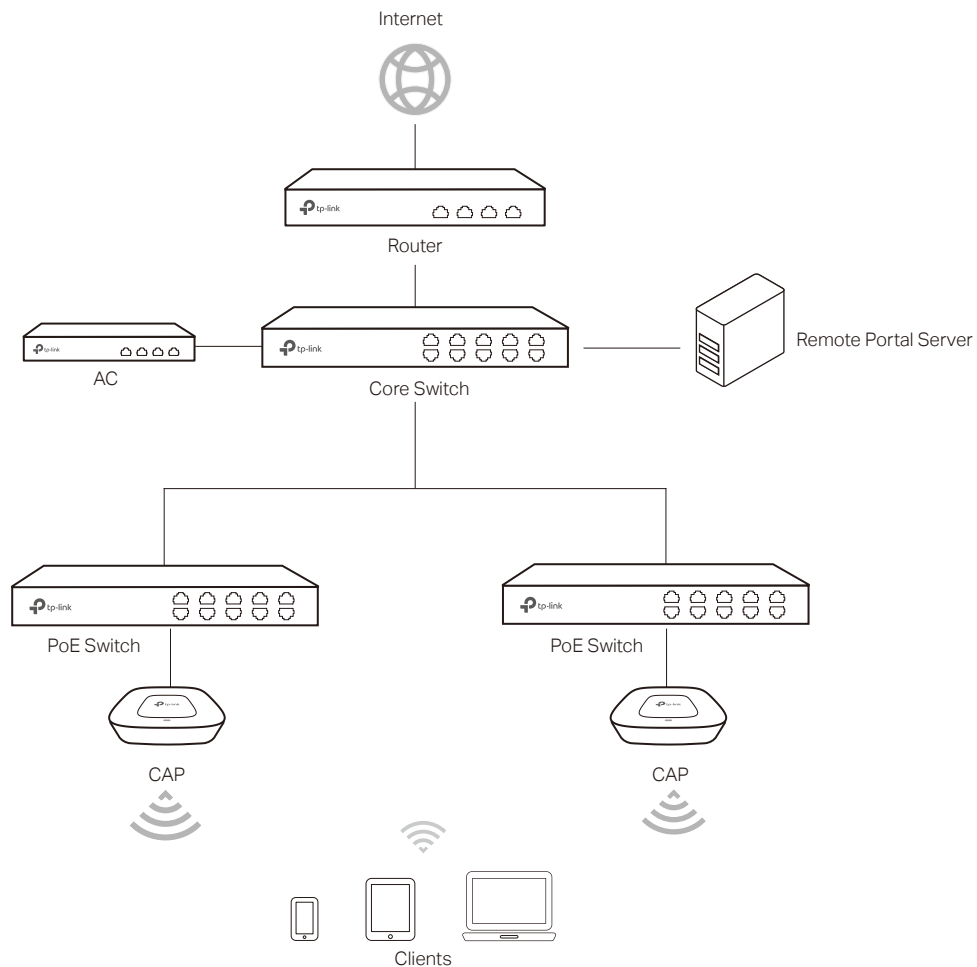

## ■ Configuration Steps

### 1 Build Remote Portal Server

Build your remote portal server on the network and make sure the connectivity between the AC and the server.

### 2 Create SSID

Create an SSID for the clients in the **Wireless** module.

### 3 Configure the Remote Portal Authentication

Choose the menu **Authentication > Portal Authentication > Remote Portal**. Click **+ Add** to add a new entry. Enable **Remote Portal** and set the related parameters.



Figure 7-61 Web Authentication Configurations

Status:  On  Off

Splash Page:  (1-50 English characters. Letters, digits, underscores or dashes are valid)

SSID:

Remote Portal Address:   
(1-100 letters, digits or special characters)

Authentication Server Type:

Success Redirect URL:   
(Optional. Enter 1-120 letters, digits or special characters)

Failure Redirect URL:   
(Optional. Enter 1-120 letters, digits or special characters)

Non-sense Authentication:  Enable  Disable

Description:  (1-50 characters, optional)

**Note:**  
1. The remote portal address and the failure redirect URL will join the free authentication policy automatically and no manual configuration is needed.  
2. If the remote authentication server is selected, and the server is configured with an online time duration for the users, then this time duration is the time that users can connect to the wireless network for free.

# 8 Link Backup

## 8.1 Dual-link Backup

Choose the menu **Link Backup > Dual-link Backup > Dual-link Backup** to load the following page. Check the option to enable the dual-link backup.

Figure 8-1 Dual-link Backup

Dual-link Backup Settings

Enable

Priority:  (0-255)

Peer Address:  (X.X.X.X)

**Note:**

1. The change of the dual-link backup settings will cause APs in the master link to reboot and APs in the standby link to disconnect from the AC. Once the connection between AP and AC is rebuilt, APs will reconnect to the master AC and standby AC according to priority.

Enable	Check this option to enable the dual-link backup function.
Priority	Specify the priority of the AC. The AC with a greater number represents a higher priority to be selected as the master link. The modification of priority will result in the reconnection of all CAPs in the master link.
Peer Address	Specify the address of the peer AC as the standby link. The CAP will get the peer address when obtaining the IP address from the DHCP server. You should enable the DHCP service on the AC.

Click **Save** to complete the configuration.

**Note:**

- If the priority and peer address are changed, the CAPs in the standby link should be rebooted to make the settings take effect. To keep the settings of the master link and standby link consistent, please reboot all the CAPs in the standby link after the modification of the settings.
- ACs used in the dual-link backup should be the same models.
- With the dual-link backup enabled, please ensure the settings of the master AC and standby AC are consistent.
- When the CAPs switch to the standby link from the master link, the authenticated wireless clients will expire and be required to re-authenticate.

## 8.2 Application

### Scenario

The dual-link backup and the standby AC are applied in the scenario that two ACs are used to manage wireless networks together.

### Topology

Figure 8-2 Topology

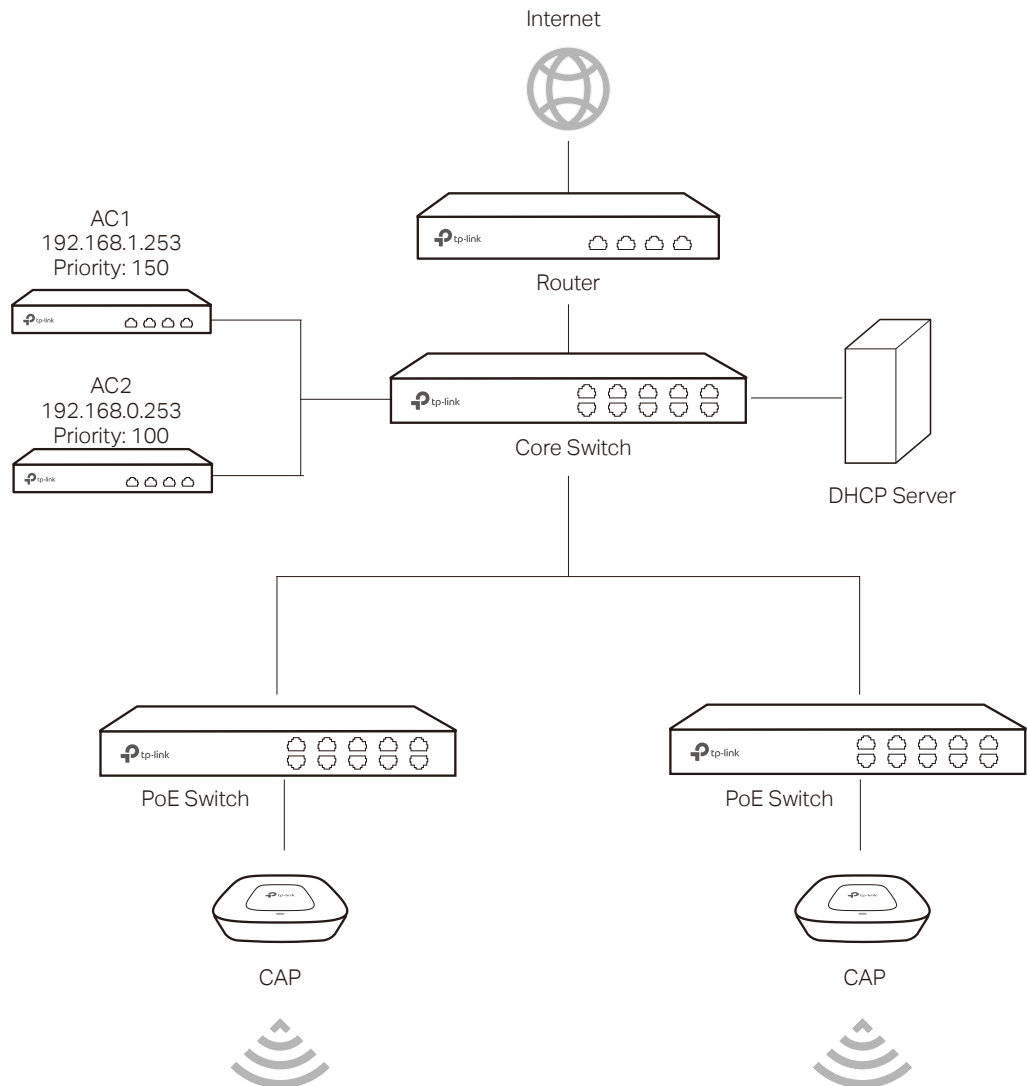

### Configuration

#### 1 Configure the external DHCP server.

The external DHCP should support the configuration of the option field. Refer to the corresponding guide for details of the option settings.

When an AP obtains an IP address from the DHCP server, it also needs the DHCP server to deliver the IP addresses of the two ACs in the network. You should configure the following parameters in the DHCP server:

Enter **TP-LINK** at the DHCP Option 60 field.

Enter the IP addresses of the two ACs into DHCP Option 138 field, therefore, the CAPs in the network can find the two ACs.

**Note:**

- Before configuring the external DHCP server, please disable the DHCP function of the AC to avoid CAPs obtaining IP addresses abnormally.
- Please enable DHCP Relay function on the core switch to ensure that the DHCP packets can be transmitted.

## 2 Configure the priority

There are several ACs in the network and they can manage all the CAPs normally. If you want CAPs to be managed by a specified AC, set a higher priority for it. When a new CAP requests to connect to an AC, the AC with higher priority will be connected first. The higher value means higher priority.

In the above topology, the priority of AC1 is 150 and AC2 is 100. Therefore the AC becomes the master controller of the CAPs and all CAPs will connect to AC1 first. AC2 is the standby controller.

## 3 Configure the standby AC

The standby AC comes into use when the master AC breaks down and cannot work normally. In this situation, the CAPs will automatically accept the management of the standby AC.

If you want CAPs to connect to another AC when the master AC malfunctions, please enter the IP address of the standby AC into the peer address field. Therefore, the master AC will deliver the IP address of the standby AC to CAPs when assigning IP addresses. CAPs will be associated with master AC and standby AC at the same time. When the master AC breaks down, the standby AC becomes the master AC.

Figure 8-3 Working Process

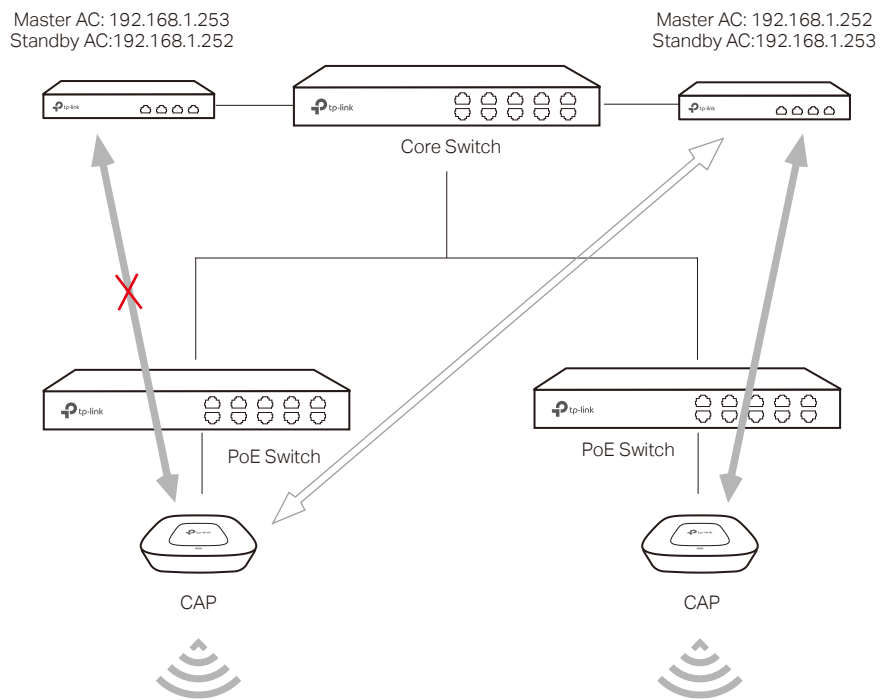

**Note:**

Standby AC should be configured along with the link priority. The AC with higher priority becomes the master AC and the lower one is the standby AC.

# 9 System Tools

## 9.1 Account

There are two types of accounts: Administrator and Operator.

- Administrator can configure and view all settings of the AC and configure the Operator account. When you buy a new AC, you will log in to the AC with the default Administrator account.
- Operator can only use the Local User Management and Voucher Management features. By default, Operator account does not exist. You can use your Administrator account to create the Operator account.

### 9.1.1 Administrator Account

Choose the menu **System Tools > Admin Setup > Administrator Account** to load the following page.

Figure 9-1 Administrator Account

Account

Old Username: admin (1-15 letters, digits or special characters)

Old Password: (6-15 letters, digits or special characters)

New Username: (1-15 letters, digits or special characters)

New Password: (6-15 letters, digits or special characters)

Confirm New Password: (6-15 letters, digits or special characters)

Low Middle High

Save

Here you can change the login username and password of the Administrator account.

Old Username	Enter the current username.
Old Password	Enter the current password.
New Username	Enter a new username. Letters, digits and special characters are allowed.
New Password	Enter a new password. Please enter a strong password to secure your device and network.
Confirm New Password	Enter the new password again for confirmation.

## Strength

Low, Middle and High indicate the password strength.

Tip: Use a combination of letters, digits and symbols to create a strong password.

## 9.1.2 Operator Account

Choose the menu **System Tools > Admin Setup > Operator Account** to load the following page.

Figure 9-2 Operator Account

Account

Set the username and password for the Operator account.

New Username:  (1-15 letters, digits or special characters)

New Password:  (6-15 letters, digits or special characters)

Low  Middle  High

Confirm New Password:  (6-15 letters, digits or special characters)

Here you can configure the login username and password of the Operator account. If the Operator account already exists, you can change the username and password of the Operator account.

### New Username

Specify a username for the account.

### New Password

Specify a password for the account.

### Confirm New Password

Enter the password again for confirmation.

## 9.1.3 System Settings

Choose the menu **System Tools > Account > Systems** to load the following page.

Figure 9-3 System Settings

Settings

HTTP Server Port:  (80, 1024-65535)

Redirect HTTP to HTTPS

HTTPS Server Port:  (443, 1024-65535)

Web Idle Timeout:  Minutes (5-60)

Here you can specify the service port and session timeout.

HTTP Server Port	Specify the web server port. Port 80 is the default. The port should not be the same as other service ports.
Redirect HTTP to HTTPS	With redirect HTTP to HTTPS enabled, the http website will be redirected to https website automatically when you log in to the management web page.
HTTPS Server Port	Specify the secure web server port. Port 443 is the default. The port should not be the same as other service ports.
Web Idle Timeout	If the device does not perform any tasks in the specified time interval, the system will log out automatically to secure the device and network. The default setting is 6 minutes.

## 9.2 Administration

### 9.2.1 Factory Default Restore

Choose the menu **System Tools > Administration > Factory Default Restore** to load the following page.

Figure 9-4 Factory Default Restore

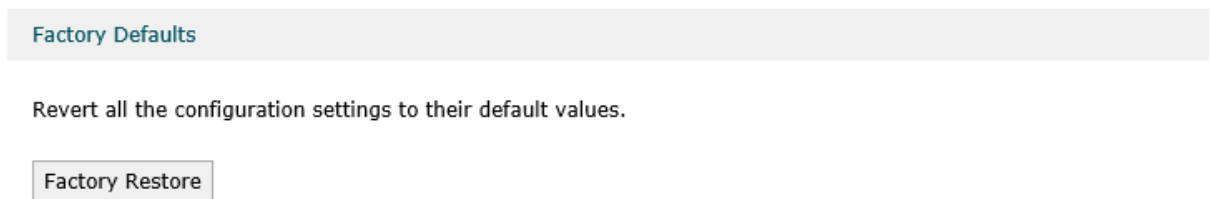

Click **Factory Restore** to restore your device to its factory default settings.

**Factory Restore** will clear all the configurations. It is highly recommended to back up your current configurations in case a recovery is needed to restore the system to a previous state or from the factory defaults.

The device will reboot after the factory restore is complete.

### 9.2.2 Backup & Restore

Choose the menu **System Tools > Administration > Backup & Restore** to load the following page.



Figure 9-5 Backup & Restore

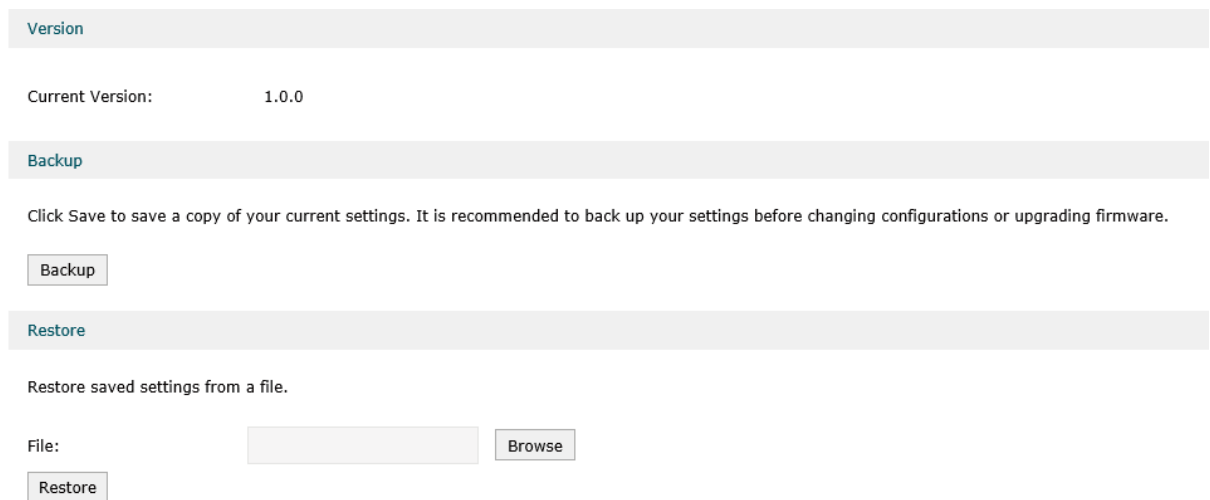

### ▪ Version

View the current version.

### ▪ Backup

Click **Backup** to save a copy of your current settings. Please save your copy in a secure file location. It is recommended to back up the settings before you change the configurations and upgrade the firmware.

### ▪ Restore

Click **Browse** to locate and select the backup file, then click **Restore** to import the file to recover the configurations.

#### Note:

- Please keep the power supply stable and avoid power off during the backup and import process.
- If the version of the imported configuration file differs a lot from the current version of the controller, the configuration information may be lost.

## 9.2.3 Reboot

Choose the menu **System Tools > Administration > Reboot** to load the following page.

Figure 9-6 Reboot



Click **Reboot** to reboot your device. Some settings will be applied only after the device has rebooted.

#### Note:

DO NOT power off your device while it is rebooting.

## 9.2.4 Firmware Upgrade

Choose the menu **System Tools > Administration > Firmware Upgrade** to load the following page.

Figure 9-7 Reboot

**Firmware Upgrade**

Firmware Version: 1.0.0 Build 20161025 Rel.49705

Hardware Version: AC500 v1.0

New Firmware File:

Here you can upgrade your firmware. Please back up your configurations before upgrading.

Click **Browse** to locate the firmware file, then click **Upgrade** to upgrade your firmware.

For the latest firmware version, please go to [www.tp-link.com](http://www.tp-link.com)

Firmware Version	Displays the current firmware version.
Hardware Version	Displays the current hardware version.

### Note:

- DO NOT power off your device or refresh the page during the upgrade. The device will reboot after the upgrade is complete.
- The configurations may be lost after upgrading. Please back up your configurations before upgrading.

## 9.3 Traffic Statistics

Choose the menu **System Tools > Traffic Statistics > Interface Statistics** to load the following page.

Figure 9-8 Interface Statice

**Statistics List**

Auto Refresh

Interface	TX Rate (Kb/s)	RX Rate (Kb/s)	TX Packet Rate (Pkt/s)	RX Packet Rate (Pkt/s)	Total TX Bytes	Total RX Bytes	Total TX Packets	Total RX Packets
GE1	1	2	11	11	333M	484M	2M	2M
Market	0	0	0	0	408	---	4	---
RDdepartment	0	0	0	0	816	---	8	---

Here you can view the traffic statistics of the interfaces and click the header to display the data in ascending or descending order.

Interface	Displays the current enabled interface of the device.
TX Rate (Kb/s)	Displays the rate data frames are transmitted.

RX Rate (Kb/s)	Displays the rate data frames are received.
TX Packet Rate (Pkt/s)	Displays the rate data packets are transmitted.
Total TX Bytes	Displays the total bytes transmitted by the interface.
Total RX Bytes	Displays the total bytes received by the interface.
Total TX Packets	Displays the total packets transmitted by the interface.
Total RX Packets	Displays the total packets received by the interface.

## 9.4 Diagnostics

Choose the menu **System Tools > Diagnostics > Diagnostics** to load the following page.

Figure 9-9 Diagnostics

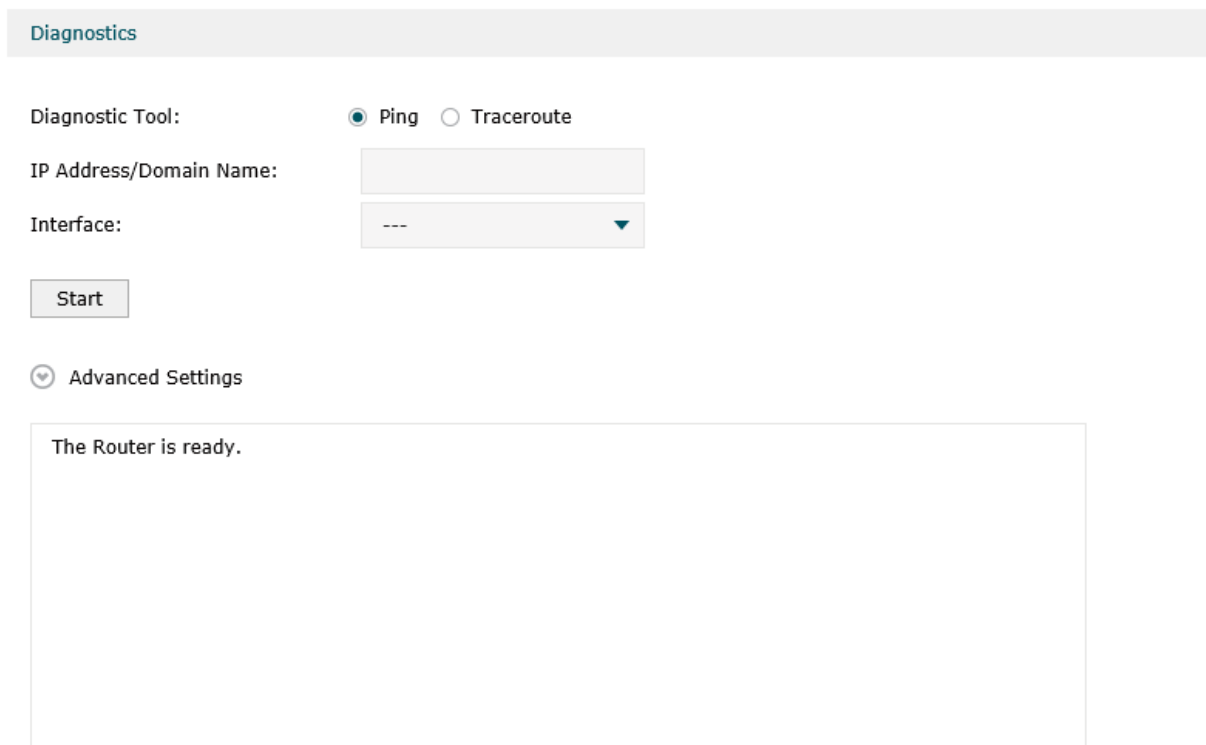

**Diagnostics**

Diagnostic Tool:  Ping  Traceroute

IP Address/Domain Name:

Interface:

Advanced Settings

The Router is ready.

Here you can use the diagnostic tools to detect the current network connection status.

The device provides **Ping** and **Traceroute** tools to help you troubleshoot network connection problems.

The Ping tool sends packets to a target IP Address or Domain Name and logs the results, such as the number of packets sent and received, and the round-trip time.

The Traceroute tool sends packets to a target IP Address or Domain Name and displays the number of hops and time to reach the destination.

Diagnostic Tool	Specify the diagnostic tool as Ping/Traceroute.
-----------------	---

IP Address/Domain Name	Enter the IP address or the domain name of the Ping host or the traceroute host.
Interface	Enter the interface of the Ping host or the traceroute host.
Ping Count	Specify the ping count.
Ping Packet Size	Specify the ping packet size.
Traceroute Max TTL	Specify the number of hops (to be reached) in the Traceroute Max TTL (Time to Live) field.

## 9.5 Time Settings

Choose the menu **System Tools > Time Settings > Time Settings** to load the following page.

Figure 9-10 Time Settings

**Time Settings**

Current Time : 11/15/2016 11:23:02

Set Time:  Get automatically from the Internet  Manually

Time Zone: (GMT) Greenwich Mean Time, Dublin, London ▼

NTP Server I: 132.163.4.102 (X.X.X.X)

NTP Server II: 131.107.13.100 (X.X.X.X, optional)

Note: only IP addresses are valid in the NTP server field.

Here you can view or set the system time. You can get the system time from the Internet, or set it manually.

- **Get automatically from the Internet**

Figure 9-11 Get Automatically from the Internet

**Time Settings**

**Current Time :** 11/15/2016 11:23:02

**Set Time:**  Get automatically from the Internet  Manually

**Time Zone:** (GMT) Greenwich Mean Time, Dublin, London ▼

**NTP Server I:** 132.163.4.102 (X.X.X.X)

**NTP Server II:** 131.107.13.100 (X.X.X.X, optional)

**Note:** only IP addresses are valid in the NTP server field.

If the AC can access the Internet, you can get the system time automatically from the Internet. The AC will search available internal NTP (Network Time Protocol) server and get the system time. If failed, please set the IP address of the NTP server manually. After the configuration, click **Save**, and the AC will get the system time from the NTP server.

<b>Current Time</b>	Displays the current system time.
<b>Set Time</b>	Specify the way the time is set (get automatically from the internet or manually).
<b>Time Zone</b>	Specify the time zone of the device.

---

NTP Server I / NTP Server II      IP Address for the NTP Server.

---

▪ **Manually**

Figure 9-12 Get Automatically From the Internet

**Time Settings**

Current Time :                    11/15/2016 15:02:25

Set Time:                     Get automatically from the Internet    Manually

Date:                     (MM/DD/YYYY)

Time:                     :  :  (HH/MM/SS)

If the AC cannot access the Internet, you should set the system time manually.

---

Current Time	Displays the current system time.
Set Time	Specify the way the time is set (get automatically from the internet or manually).
Date	Specify the time zone of the device.
Time	IP Address for the NTP Server.
Synchronize with PC's Clock	Click this button, and the system time of the device will be matched with the current time on the host PC.

---

**Note:**

AC500 has a built-in RTC (Real-time Clock) chip, the system time won't be restored to the default time setting when the AC is rebooted or powered off. AC50 doesn't have an RTC chip. Please set the time manually or connect to the internet to set the time after the device is rebooted or powered off.

## 9.6 System Log

Choose the menu **System Tools > System Log > System Log** to load the following page.

Figure 9-13 System Log

### Log Settings

Log Level Filter All Level

Module Filter All Module

Send Log

Server IP Address: 0.0.0.0

Save

### Backup Log Information

Save Log

### System Log

Clear Search Refresh  Auto Refresh

ID	Time	Module	Level	Log Content
--	--	--	--	--

### Log Settings

#### Log Level Filter

Displays a list of the most recent activity (events) on the network. You can define the level of logs you want to view in the log level filter dropdown list.

**All level:** Displays all level of the system logs.

**EMERGENCY:** Displays emergency system logs. These are fatal errors that may result in system breakdown.

**ALERT:** Displays alert system logs. These are serious errors that require urgent system repair.

**CRITICAL:** Displays critical system logs. These are fatal errors that may result in danger to the system.

**ERRORS:** Displays error system logs. These are ordinary errors in the system.

**WARNING:** Displays warning system logs. These are warning messages that remind the user that there may be some hidden threats to the system.

**NOTICE:** Displays notice system logs. These are important notices about the system.

**INFO:** Displays ordinary system information.

**DEBUG:** Displays the debug information.

---

## Module Filter

You can define the module of logs you want to view in the module filter dropdown list.

**ALL Module:** Displays all system log modules.

**System Management:** Displays the system's management log, including the account, device management and time settings.

**Interface Management:** Displays the system's interface management log.

**DHCP server:** Displays the system's DHCP server log.

**AP Control:** Displays the system's AP control log.

**AP Upgrade:** Displays the system's AP upgrade log.

**AP database:** Displays the system's AP database log.

**Radio:** Displays the system's radio settings log.

**Link Backup:** Displays the system's link backup log.

**Portal authentication:** Displays the system's portal authentication log.

**MAC Authentication:** Displays the system's MAC authentication log.

**User Management:** Displays the system's user management log.

**Wireless service:** Displays the system's wireless service log.

**Wireless Client:** Displays the system's client log.

**Load Balancing:** Displays the system's load balancing log.

---

## Send Log

Check the box and specify the server address the log will be sent to.

---

### ■ Backup Log Information

Click **Save Log** to save the system log.

### ■ System Log

Displays the system log.